

ELECTRON TOP

MANUFACTURING CO.

Manufacturers of Quality Domestic & Foreign Convertible Tops

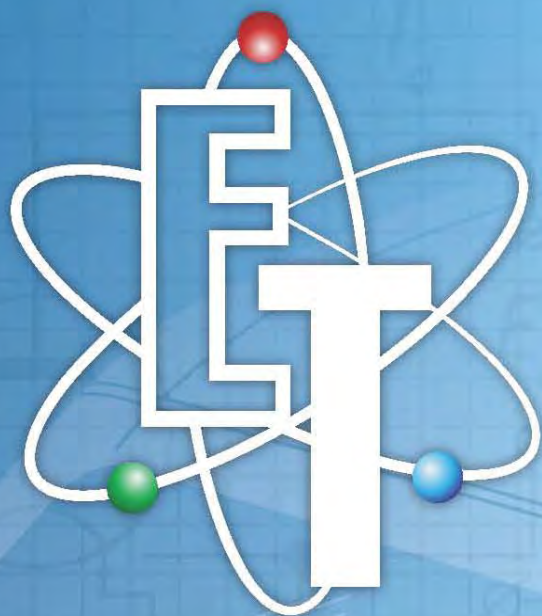

“Our Reputation
is TOPS!”

2014

Over 50 Years of Experience

Call Toll Free (800) 221-4476

Retro design taken from our first 1963 edition

Electron Top

Manufacturing Company

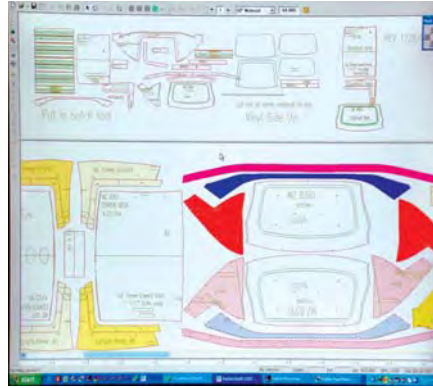

One of Our Products is Service

"*WE* believe that business should be more than just a cold transaction".

When you call *Electron*, whether it be technical information or to place an order, you can always expect a pleasant voice on the other end.

The Final Touch

For some time now *Electron* has been transferring its original master patterns to a computer system. Above, the digitized pattern is receiving the final touch up and is nested for the computer cutting table.

Accurate Beyond Belief

WE have the latest in single ply computerized cutting with accuracy that can be within five thousandths of an inch. The new cutting system totally eliminates the wear and inaccuracy that can occur when using paper patterns.



Proper Assembly

Our sewing machine operators are the best. All of our operators have been trained here at *Electron* to fit into our way of doing things right. Most have been with us for more than a decade and are the nucleus of our operation.

Updated Technology

WE use the newest in controlled heat sealing equipment. The machines are better, cleaner, and safer to operate than the older machines.

Careful Transfer of Patterns

Each pattern is carefully transferred, through direct digitizing, from time proven paper patterns. Every one of our patterns is given special attention to its originality and detail, to assure a proven fit and lasting performance that

WE are famous for.

Electron Top

Table of Contents

How "WE" Make Tops -----	Front Cover	Conversion Tops -----	34
Fifty Four Years in the Making -----	2	Bow Height (How to Measure) -----	107
"WE" Story -----	12	Distributors Map -----	108
Warranty and Return Policy -----	14	Cables -----	110
Pricing Guide and Universal Glass -----	15	Pads -----	117
Misc Price Sheet -----	17	Materials -----	120
Pictures of Custom Quality Tops -----	33	In House Sales Team -----	Rear Cover

ALFA ROMEO -----	71	LANCIA -----	85
AMPHICAR -----	72	LINCOLN (CLASSIC) -----	51
ASTON MARTIN -----	72	LINCOLN -----	52
AUDI -----	73	MASERATI -----	31 & 86
AUSTIN HEALEY -----	74	MAZDA -----	86
AVANTI -----	18	MCLAREN -----	49 & 55
BMW -----	75	MERCEDES -----	88
BUICK -----	18	MERCURY -----	53
CADILLAC -----	22	MG -----	90
CHEVROLET -----	24	MG MIDGET -----	91
CAMARO -----	27	MINI COOPER -----	92
CHRYSLER -----	30	MITSUBISHI -----	92
CITROEN -----	77	MORRIS MINOR -----	93
CORVETTE -----	35	NASH METROPOLITAN -----	93
DAIMLER -----	77	NISSAN -----	93
DATSUN -----	78	OLDSMOBILE -----	57
DESOTO -----	38	OPEL -----	94
DODGE -----	39	PACKARD -----	60
DUAL GHIA -----	78	PEUGEOT -----	94
EDSEL -----	42	PLYMOUTH -----	60
FACEL VEGA -----	78	PONTIAC -----	62
FERRARI -----	78	PORSCHE -----	94
FIAT -----	79	RAGTIME MINI -----	97
FIREBIRD -----	65	RAMBLER -----	67
FORD -----	42	RENAULT -----	97
FORD CONSUL & ZEPHYR -----	79	ROLLS ROYCE -----	98
GEO METRO -----	28	SAAB -----	98
HILLMAN -----	80	SMART CAR -----	99
HONDA -----	80	SPORT UTILITY VEHICLES -----	68
IMPERIAL -----	50	STUDEBAKER -----	69
INFINITI -----	81	SUNBEAM -----	100
ITALIA -----	81	THUNDERBIRD -----	70
JAGUAR -----	82	TOYOTA -----	101
JEEP (Also Sport Utility Vehicles) -----	68	TRIUMPH -----	103
JEEPSTER -----	50	TVR -----	104
JENSEN HEALEY -----	84	VOLKSWAGEN -----	104
KARMANN GHIA -----	84	VOLVO -----	106

COPYRIGHT

All text, drawings and diagrams contained in this catalog, as well as its layout and designs, are copyrighted material. Any use of this copyrighted material without the express written permission of

Electron Top Mfg. Co. Inc. is strictly prohibited.

"54 YEARS IN THE MAKING"

Business experts have said that family companies rarely survive past a second generation of ownership. We are elated to say that in June of 2010 we celebrated our 50th Anniversary and are on the third generation of family owners. We tried to capture some of the highlights of our last 54 years of existence on the following pages.

"The Beginning, First Generation and Grandpa Yudt"



Grandpa
c. 1910

Our Grandfather Henry Yudt; at age 12 (Left), as an apprentice carriage builder in Budapest, Hungary. He emigrated to New York City in 1920 and went to work in the custom auto body building industry, that was flourishing at the time.

In 1930 he went into the Auto Trim business as "Richmond Hill Auto Top." His attention to detail, incredible craftsmanship and kind personality made him an upholsterer sought after.



Grandpa in front of his
work bench c.1931.

Grandpa was the first Auto Trim Association Hall of Fame recipient.



M G's in front of Richmond Hill Auto Top.
Grandpa had the building erected in 1948.

Whilst Grandpa was busy with Richmond Hill Auto Top, our Nanny stayed at home taking care of all the important things that a house required to be called a home. She was very supportive of her husband; our grandfather, and did a great job of raising their three children in a very loving environment. She was also an incredible baker.



Grandpa inspecting the progress on an upholstery job (Below).



Grandpa Yudt (L) & his brother Ferdinand (R) (WE called him Vati Onkel, meaning Daddy Uncle in English), custom trimming a new convertible top. They both had a great reputation for quality craftsmanship and a kind demeanor (Above).

Our Mom recalls, when she was younger; about 10, she would ride her bicycle to Grandpa's shop to bring him Nanny's homemade lunch. It was a 4 mile ride and she rode it quite often...
ok, so this isn't Mom at age 10; nor is it the bicycle she was riding, but it's the only picture we had of Mom on a bike (Below).



Richmond Hill Auto Top, 135-11 Hillside Ave. c. 1950.

Grandpa had a new building erected in 1948 capable of handling the expansion of Richmond Hill Auto Top. He had 12 trimmers working for him, two of which were his brother Ferdinand and son-in-law, our Dad, Fred. Later Mom's brother Henry went to work for Grandpa and ran Richmond Hill Auto Top up until his retirement in 2001. Our Dad, Fred (L), Grandpa Yudt (2nd from left), and Grandpa's Brother Ferdinand Yudt (9th from Left).

Grandpa Yudt behind his desk in the showroom of Richmond Hill Auto Top; The Shop on Hillside Avenue, with an early display of Electron Top in their showroom (Right).

Like most family run business', the past generation continued to lend moral support and share their knowledge even after retirement. Grandpa would occasionally stop in and see how things were going (Below).



Grandpa Yudt was a wonderful man whose kind heart was exposed on a regular basis. He was a true gentleman and a person who loved to laugh, tease and sing. He kept a little black book in his drawer that he would write jokes in and keep the grandchildren entertained with the many puns held in its interior. His days as an apprentice in Yugoslavia were long gone, but the conviction he gained for honesty and integrity stayed with him till his passing in 1986.

"Second Generation; Our Dad, Fred"

Our Dad was the first president of the Automotive Trimmers Association of New York.



Dads real father died when our eldest sister Linda was very young. Grandpa Yudt treated our Dad like his own son.

Back in the 50's there were "Trimorama" competitions and our Dad won 2nd place with the seats pictured to the right.

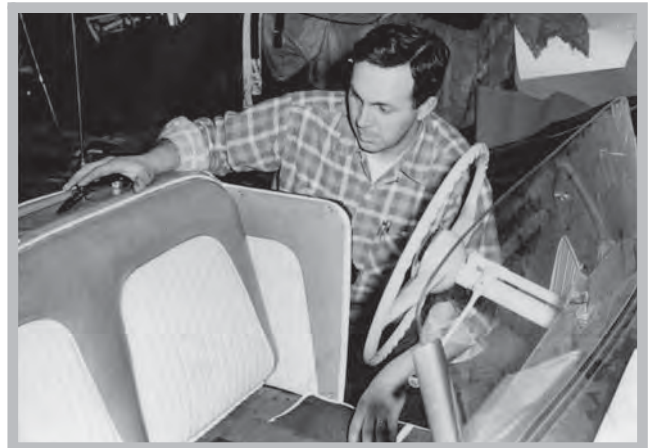



Mom (L) and Dad (R) presenting an Auto Trimmers Association Award.



Dad would organize top installation demonstrations and Auto Trim Dinners (Below) in the 1960's. They were held in the shop at Richmond Hill Auto Top. Some of the attendees included such pioneers of our industry like Nat Danas (L), seated along with Nelson Butterfield (Haartz Auto Fabric), our Dad, Fred and Ken Richie (Haartz Auto Fabric).



Dad made a handmade metal ET. This was the backdrop used at some of the Auto Trimmers Association gatherings that took place at Richmond Hill Auto Top in the 1960's (L).



Dad always said, "Find a need and fulfill it." In the 1950's and 60's Dad competed with running field dogs. During that time he developed a very durable chap made out of Naughahyde. He called them Field Chaps and *We* produced and sold them at Electron Top until 1989. In 1999 *We* contemplated making them again but the material had become too costly.



Our sister Linda (1945-2002), was the eldest of the Strauss children (below). She participated in the earlier building of Electron Top and accompanied Mom & Dad at local events. In 1975 she married, bought a funeral home and later an embroidery business in Virginia where she raised her five girls.



In the early years, Dad would attend Trade Shows representing Electron Top and Richmond Hill Auto Top.

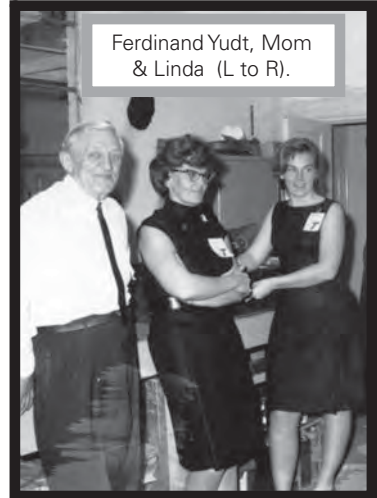

Ferdinand Yudt, Mom & Linda (L to R).

Last Convertible Rolls Off Line

With all the hoopla usually accompanying the introduction of a new model, the last American-built convertible has rolled off the assembly line at Detroit.

It ends a 74-year era of American rag tops and of cruising down the avenue with the wind whipping casually through a person's hair.

The \$11,049 white Cadillac Eldorado, driven by Edward C. Kennard, Cadillac general manager, was the 200th "Last of the Convertibles" built by Cadillac. The car is being kept by General Motors for "historical purposes," Kennard said.

Cars Bear Plaques

The other 199 cars—each emblazoned with a plaque saying, "This 1976 Fleetwood Eldorado is one of the last 200 id convertibles produced in a drive Cadillac's 1,600 dealers."

Kennard was accompanied by Mayor Coleman Young of Detroit, and H. B. Brawner, general manufacturing manager of Cadillac. He wheeled the car amid balloons, banners and people dressed in jackets and shirts proclaiming their love for the last soft top.

Several hundred and office workers at the complex cheered as the engine roared to life and

have sold 20,000 cars if it had had enough tops.

His prediction earlier this year that the final soft tops would become collector's items appears to be coming true. Some dealers offered \$2,000 above cost for the vehicles.

Predicts Return

Mayor Young, who said he's owned six or eight convertibles, said he didn't think an era had come to a permanent end.

"With the law of supply and demand," he said, "I think some enterprising auto maker will start making rag tops again."

Woodrow Powe, who installs fender braces on the assembly line for Cadillac, agreed.

"In three or four years," he said, "we'll be building 10,000 more."

After 60 years of automobile existence, the last American made convertible vehicle rolled off the General Motors production line in 1976. It was a very uneasy time for us. We didn't know what the future had in store, but as always "Everything always works out!"

HALL of FAME

Fred Strauss
A Man Who Lit Up The Industry

In 1986 Dad was inducted into the Auto Upholsters Hall of Fame. It was a wonderful honor for him especially when his award was presented to him by his long time friend and "Father of our Auto Trim Industry," Nat Danas. Rick, Dad, Nat and Skip. (L to R Below)



Not until 1948, that Fred began his career in auto trim by going to work for his father-in-law at Richmond Hill Auto Top. Fred continued to work at Richmond Hill for a number of years, before splitting the company to form Electron Top in 1966. A firm believer in this industry, Strauss saw his sons, Rick and Skip, become involved with the business, creating a third generation of master-craftsmen devoted to quality. Fred Strauss is now thinking about retiring, having built a house and barn in upstate New York, and just finishing a log cabin in the Adirondacks. He also enjoys bass fishing at his condo in Florida. Fred finds a great deal of pleasure, these days, in his complete wood working shop; as well, when he's "not running around on his ATV's," and is currently restoring a 1967 Amphicar, which he hopes to have in the water this summer.



Mom & Dads last convertible was a 1976 Cadillac Eldorado.

THE END: The last American-made convertible—a Cadillac Eldorado—rolls off the assembly line at the Cadillac plant of General Motors at Detroit. Riding the car off the line are (left to right) H. B.

Brawner, general manufacturing manager of Cadillac; Mayor Coleman Young, of Detroit, and Edward Kennard, general manager of Cadillac. Cadillac employees watch.

"The Convertible Comeback"



In 1982, Chrysler & Volkswagen brought the Convertible Automobile back. "Things worked out" and we flourished due to the renewed interest in rag tops sparked by the realization of the possible value of restorable convertible vehicles.



Kimmy & Dad 1986



We have always thought of our Dad as being a great contributor to the Auto Trim Industry and a special man. It was a terrific feeling for all our family knowing *We were not being bias.*



Dad & Nat 1986



Dad always told us, "Never take your hands off the work (your product)" He never did, and continued to guide and teach us, even after his retirement in 1987.

10 years after retirement Dad was honored on the cover of Auto Trim News. He shared the honor with David Eash & Richard Gilbreath of E & G Classics, Gaither Spradling of Spradling Originals and Jerry Roman of Roman Chariot.

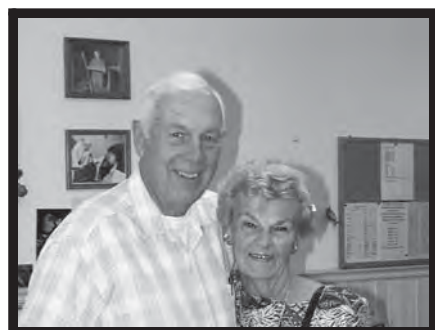
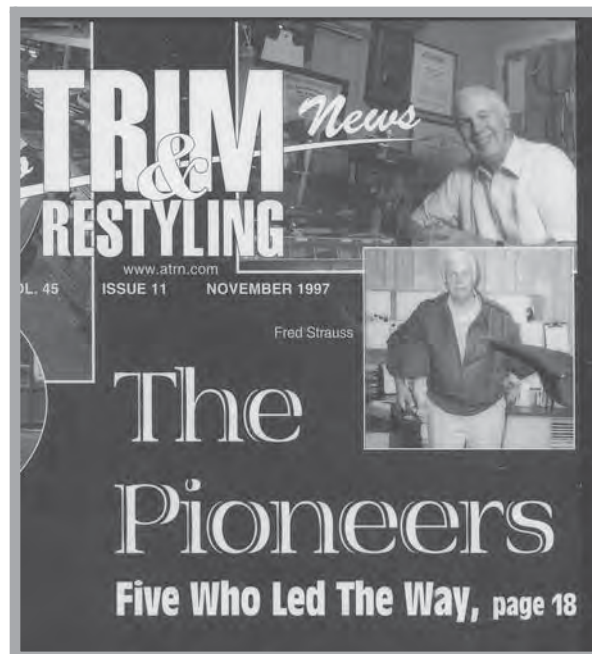

Like most successful people, our Dad was accompanied on his journey by our Mom. Mom took on any job that needed to be done with a positive attitude and enthusiasm. Some of her jobs included accounting, making sample cards (which were cut by hand then), going on sales trips, but most of all being supportive of Dads dreams. Mom continues to come into work on Mondays and support us. Our Mom and Dad made a great team. Their logic, foresight and strong relationship created a firm foundation for us to build on. They ran Electron Top very successfully for 27 years before passing it on to Rick & Skip.

We painted our name on the interior wall of our shop. It reminds us to this day that *We* did not arrive to this point without a lot of hard work and dedication not only by ourselves but also by our elders. Dad with his two boys and companions.

Skip (L) & Rick (R)



"Flag Day"

Every year on Flag Day; June 14th, *WE* celebrate the anniversary of the birth of *Electron Top*. In 2001, *WE* changed the name of our celebration to "Founders Day". Dad was with us to enjoy that first year.



Our Dad left behind a script that could be adapted to all our business and personal issues. We are grateful for the person he was and the people he helped us to be, but mostly for the endless love he shared. *We* miss him dearly. (1922-2002)

"Third Generation Rick, Skip & Kimmy"

Dad was a very social man that enjoyed the company of his peers. He enjoyed hosting upholstery installation and Auto Trim Association dinners in order to share his knowledge and create a mutual bond within the industry. He spent many years perpetuating his talent and experience with his employees; always with the idea in mind of maintaining quality and craftsmanship. Two of those employees were his sons Rick & Skip. His boys learned from the bottom up and were taught that being the boss' son did not represent privilege; it meant that they had to work harder than anyone else to prove themselves to other employees. Skip and Rick have done a great job of maintaining Dads ideals and complimenting them with their own.

After almost two decades of working as Dads apprentices Rick (L) & Skip (R) decided to continue, what had become a family tradition. They took over ownership of *Electron Top* in 1987. Dad later remarked, "The best compliment I have ever received was from a customer who had been dealing with Electron Top for many years." He recalled, the customer saying "Fred nothing changed when you left."



Rick (L), Dad (C) & Skip (R) learning the ropes from Dad at an Auto Trim Show.



Since the third generation of ownership, Rick & Skip have been a catalyst for many changes. Electron Top has experienced great growth both in a loyal following of customers and a workforce that averages 17 years of employment. They mesh old world craftsmanship with new age technology by bringing in computerized cutting, hot air sealing, digitizing and also photo-capturing of patterns, and in 1994 the manufacturing of glass rear windows.



Richmond Hill Auto Top "Where it all began"
135-10 Hillside Avenue Richmond Hill, NY. (c.1930-1948)



Richmond Hill Auto Top/Electron Top
135-11 Hillside Avenue Richmond Hill, New York c. 1948



We have never been accustomed to hiring people to do a job we feel we can do ourselves. This includes moving a heatseal machine down the street to our newest location on 89th Avenue. WE maintain all our equipment, machines and structures inhouse.



Electron Top 89-15 127th Street
Richmond Hill, NY (1989-Current)



Electron Top 126-15 89th Avenue
Richmond Hill, NY (1994-Current)



WOMEN IN THE INDUSTRY

If a Woman Answers... Don't Hang Up!

More and more women are traditionally been

By Amy K

Looking at the approach of the final decade of the 20th century brings to mind innumerable changes and innovations. Americans have survived two world wars, two Asian wars, put a man on the moon, seen the advent of moving pictures, talking pictures, TV, microcomputers



al like to, she go and d Skip I Rick ex. is in to, she

amphicar to her father Fred, who started

Kimmy joins her brothers in 1988, celebrated in an article in Auto Trim News.

"It is sometimes difficult for the older generation of business owners to accept changes made by the younger, but Mom and Dad always displayed great enthusiasm and pride towards the job WE were doing. They made regular trips to *Electron Top* displaying enthusiasm and interest towards every new change." Skip, Mom, Dad & Rick (L to R) in 1994.



"Keeping in Touch!"

1994 Domestic Car Identification Update

January 1994 - The first issue of our monthly newsletter, "Keeping In Touch" is released. The name was changed the following month to "Keep in Touch." The letter was created to "Keep in Touch" with our customers and them with us.



1993-94 Chevrolet "Chevy" front, pickup the GM-2010 "Chevy" 1970s, are found
1993-94 Chrysler "Latter" than the earlier models (1993) has a blacked-out, and available for the first time
1993 Chevrolet "Corvette" into the 1990s
1993 Dodge Dakota Pick-up, there "It is best to remove
1993 Dodge "Shadow" (1993)
1994 Ford "Mustang" (1994) better one. Unlike the earlier model which couldn't get 200
1994 Mercury "Capri" (1994) recently perfected the auto seat belt to be transferred from Capri to
1990-94 Oldsmobile "Cutaway" manufacturing the cutaway features apply. It comes in 1990-94 models "Lexus"

Kimmy, Linda and Dad in 2001 (L to R) "Taking a ride in *Electron Top's* Mascot" c. 2001



"Visiting Customers"

1960's - Dad spent many days throughout the 60's visiting upholstery shops promoting our products. Those visits established relationships that, in many cases, still exist today. Some of you may even remember him flying to your local airport in his Cherokee Piper.

1976 - 1988 - Being very loquacious and a bit of a free spirit, Rick took over sale's visits traveling to our customers on the East Coast in a Realite motor home. He; like Dad, did a great job maintaining relationships with our customers.

1988 - 1990 - After many years of exposure to the convertible top business, Kimmy took over the pleasure of visiting customers on the east coast. Mom and Dad were against overnight trips except when she could spend the night with her sister Linda and 5 nieces in Virginia. No, we never visited customers in an Amphicar!



Skip at a Philadelphia Auto Trim Show

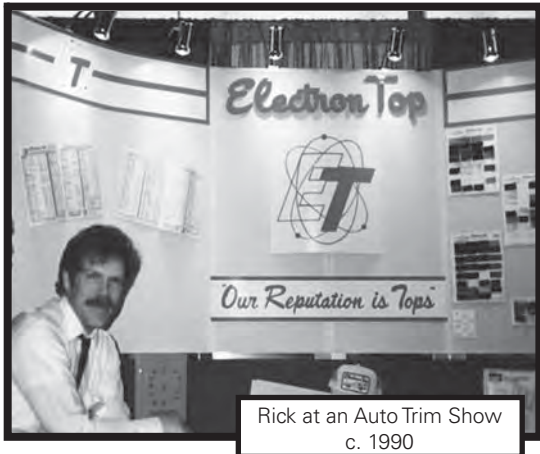

Rick at an Auto Trim Show c. 1990

Rick, Kimmy and sometimes Skip travelled to the different trade shows meeting customers in person, sometimes for the first time. Many times *We* recognized a customer by the sound of their voice before *We* knew who they were.



Rick and Kimmy at an Auto Trim Show c. 1993

" Reminiscence of *Electron Top* " Family, Friends & Crew - Past & Present



Mom in an early advertisement for "Sledsheds"



Sam & Barbara Colerider Auto Trim Trade Show



Christmas (L to R) Cathy, Fina & Tracey

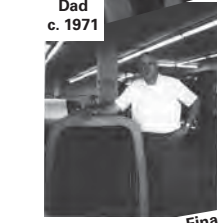

Dad c. 1971



Tracey, Mom, Kimmy, Fina and Cathy (L to R)



"Founders Day" Cathy, Mom & Skip (L to R).



Electron Top Crew c. 1967



Rick & Fina (L to R) ET Easter Bunnies



Cathy handling UPS



Christmas 1967 (L to R) Rick, Linda, Kimmy & Skip



1994 Assessing our New Location (L to R) Rick, Dad, Deo & Skip



ET Installation meeting (L to R) Mom & Skip c. 1965



Kimmy & Nat Danas



Tracey inspecting packaging



Marty Karzmar & Rick (L to R)



Dad & Fina (Fina has been with Electron 31 years)



Rick & Skip (L to R) 127th St Location Our own Shirley Temple



Our Grandparents and Parents created a legacy in *Electron Top* that continues to support us and a firm foundation that we continue to build on. For all this and more we are truly grateful.



Linda & Dad 2000



"A little parking lot exercise." Kimmy & Tracey (L to R)



Rick Digitizing



Kimmy ... "Who did that?"



Top Installation Party c. 1964



2009 Cathy St. Patricks Day

Founders Day 2008 (L to R) Raj, Deo, Rick, Tracey, Cathy, Kimmy, Mom, Skip, & Fina



Kimmy, Fina & Tracey (L to R)



Deo "Shop Foreman" with Electron 28 years



Skip, Mom, Kimmy, Dad, Linda & Rick (L to R) 1964 U.S. National Parks Adventure (6 Strauss family members in a 22 foot Airstream trailer for 10 weeks).

Kimmy testing the strength of the "Sledshed" framework c. 1971 "Don't feed the animals!"



Mildred, Theo & Terry (L to R) Mildred worked for us for 27 years before retiring.



Kimmy with ET display at an Auto Trim Show c. 1993



Kimmy, Tracey, Fina & Cathy (L to R)

Childhood Memories

Rick

I remember watching the old German men spitting tacks and hand making all the tops and interior upholstery. Later I remember Dad making patterns out of oak tag for the quarters of tops that would later be the beginning of our basic pattern source today. I recall being in Dad and Grandpas upholstery shop picking up hog rings with a rolling magnet type of thing so they would not puncture the tires of the cars, constructing shipping boxes using an old hand cranked stapler and also sweeping the floors. I also remember the Christmas parties in the shop; Dad always made sure everyone received a ham, a bottle of spirits and the children of all the employees received gifts.

Skip

Working with Dad as a young boy I also remember he had started Rick and I doing odd jobs like sweeping the floors and picking up hog rings. I was infatuated with all the different tools that were used by the trimmers to fabricate new tops, seats and interior items.

I was especially interested in the pneumatic staple gun that Rick and I used to shoot at each other until *We* got reprimanded. I remember Grandpa kept pennies in his drawer that *We* were always privileged to use in his gumball machine. As I got older I was given jobs that were appropriate for my age; like backing cars out of the shop for Grandpa. One car I backed into the opening for the garage door ... oops, I was 12.

Our Dad took great joy and responsibility in the perpetuation of his knowledge, skills and life lessons. I am grateful for the person he was. I will always be intrigued by the abilities he had, his kind mannerism and his ability to communicate to others his vast knowledge in so many fields.

Kimmy

To this day the smell of vinyl convertible top material still reminds me of being a little girl going into work with Dad and him calling me his "little shaver." It was difficult waking up at 5:00 am but it was all worth it when *We* stopped at the Greek diner to pick up the biggest blueberry muffins I had ever had. My first job on those early mornings was to walk over to Richmond Hill Auto Top (for a long time Electron occupied the same building) and give Grandpa and Uncle Hank (Moms brother) a kiss hello. Grandpa would give me quarters to buy candy or a soda from the machines. The soda came in little glass bottles and there was a bottle opener attached to the machine. I remember rolling wire-on for .05 cents a piece, .01 cent per bag to pack end-tips with screws (a good day could bring up to \$15) and playing with all the office machines. I remember Dads rules were strict but loving, and the lessons were endless and sometimes tough: "If you want our employees to respect you, you have to work twice as hard and as well as them"; "Our first product is not convertible tops but people so be respectful" and "Don't ever contradict me." Most of all I remember Dads smile - it was often and it made his eyes twinkle.

WE have been working together since 1988. Working with family can be trying at times but the rewards are in abundance.



"We are not the beginning nor the end."

Strauss Grandkids

Jenna, Caitlyn, Courtney, Lauren,
Lindsey,
Christopher, Chrissi,
Jillian (JillyBean),
Tabitha, Lori, Lisa
(pregnant with Addison)
(L to R).



Electron Top Facts

- ** Dad made the suggestion to Haartz Auto Fabric to extrude vinyl on a preshrunk lining to avoid excessive shrinkage that was a problem with vinyls made in the 50's.
- ** We used to be called Electron Sales.
- ** Our logo used to be red not blue.
- ** Rick, Skip & Kimmy all worked for Electron Top more than once.
- ** We used to make vinyl sheds for snowmobiles.
- ** The name *Electron Top* came from the use of electronic heat-seal equipment and referred to the electrons that made up the radio frequency (R.F.) waves that create the heat used for sealing the vinyl.
- ** The average length of time for an employee to work with Electron Top is 17 years.

"WE", is a story spanning three generations of a family engaged in the Auto Trim Industry that eventually led to the creation of "*Electron Top*". Our Dad, Fred W. Strauss Jr., deplored the use of the word "I" in conducting business. He often reminded us of a book that Charles Lindbergh wrote about his solo accomplishment crossing the Atlantic in 1927 that was named "*WE*", in recognition of the support received from others. Our story cannot match that of Lindbergh's heroic deed in significance, but "*WE*" hope it will keep us ever mindful of the help and support one gets from family and business associates. Sometimes help comes from strange and unexpected places. When you look back on your own accomplishments, you will probably realize too, that you didn't do it alone.

The late Henry Yudt (1897-1989), our Grandfather, was born in Hungary and started his apprenticeship at age 12 in a carriage factory in Budapest. During World War I he did upholstery for aircrafts. In 1920 he came to America and while learning to speak English worked in the custom auto body building shops that flourished in New York City at the time. By 1930 he went into the Auto Trim business as "Richmond Hill Auto Top" in a rented store in Queens, NY. In 1948 a new building was erected directly across the street from the original shop. The original trim shop, in business for over 60 years, was operated since 1965 by his son Henry until closing its doors in Fall 2001. Henry Yudt Sr. was a craftsman and businessman of the highest caliber and he was the first "HALL OF FAME" recipient in the Auto Trim Industry.

SECOND GENERATION

Fred W. Strauss Jr., of a later generation than Mr. Yudt, was trained as an aircraft mechanic, and went to work for Grumman Aircraft Co. in 1940. He worked until 1942, when he enlisted in the Navy flight program to fulfill a life long ambition to become a Naval Aviator. After being commissioned as a Naval Aviator in 1945, he married Henry Yudt's daughter, Catherine, our Mother. Upon returning to civilian life in late 1947, he returned to Grumman until mid 1948 when he went to work for his father-in-law in the Auto Trim Industry. Henry Yudt Sr. and Fred Strauss Jr. earned a fine reputation as operators of one of the most successful custom trim shops in the New York area and in 1955 Fred W Strauss Jr. (Our Dad) became the first President of the Auto Trim Association of New York.

In 1958-59 a few years after the introduction of vinyl coated top materials, the electronic fused (heat sealed) seams appeared on factory tops. This created a problem for a complete custom trim shop, like Richmond Hill Auto Top. It meant that "*WE*" would have to buy our tops from the larger less quality oriented manufacturers, or invest in heat seal equipment and learn how to use it. During the same period of time in the late 50's, the mixture of old and new ideas grew gradually from making convertible tops by cutting, fitting, and stitching each and every top individually, to a unique semi-modern pattern and production method. "*WE*" chose to buy heat seal equipment and were probably the only custom trim shop to heat seal their own tops. Almost before the equipment was in place, (knowing the reputation of Henry Yudt Sr. and Fred Strauss Jr. for quality and craftsmanship) "*WE*" were approached by several jobbers who were interested in selling tops made by "Richmond Hill Auto Top".

THE BIRTH OF *Electron Top*

In 1960, out of one of the oldest trim shops in the northeast "*Electron Top*", was born. "*WE*" chose Marbeth Fabrics to do selling for us and enjoyed several years of steady growth. In the early 1960's, Marbeth Fabrics reorganized. Marty Karzmar lost his partner Jack Rosenthal and "*Electron Top*" was left without a selling organization, so our Dad did the selling. In 1965 Dad bought Cherokee (180) an airplane, a visiting custom-some of you and flew around his visits, since I'm sure most of you are still valued the next few customers. For some good key years he left the in the hands of men. However,



in the normal evolution of things one key man left *Electron* and became a very successful marine canvas man. A year or so later our foreman was offered a job as a service manager in a family owned Toyota dealership near his home (an offer he couldn't refuse). So our Dad rolled up his sleeves and went back to the hands on production and pattern making with special attention given to Mercedes and other Imports.

He vowed never to stop working with his hands again and never did. Dad always said :

"The harder he worked the luckier he got!"

"*WE*" all have fond memories of working for Dad as young children on days off and during summer vacations from school. Some of our jobs involved rolling wire-on for 5 cents each, packaging end tips with screws for a penny a piece, hand cutting swatches, and pasting sample cards for 25 cents each. "*WE*" also engaged in sweeping the floor and picking up hog rings in the trim shop, which "*WE*" did not get paid for. Most fathers would like to have their sons and daughters join them in a family business. Our father was no exception. Dad was receptive, but the boys and Kimmy wanted no part of the regimentation that a training program under Dad's scrutiny would bring. They had enough of that through their school days.

Craig (Skip) was not overly enthusiastic about academics in school, but he excelled in mechanics and electronics. He was thrilled by any opportunity to take apart, put together, or modify anything that had an engine or battery. He built a dune buggy, rebuilt a bulldozer for Dad, and learned how to fly airplanes, both full scale and radio controlled. After some interesting jobs, mostly connected to the automotive industry, Skip took some electronics and computer programming courses. Skip realized that computers could satisfy his desire to work with his hands without getting them dirty. His thirst for knowledge, never ending ambition, and love for new technology brought the new age to *Electron*. Skip is responsible for all the computer programming, our computerized cutting machines and the composition of our advertising, catalog and top patterns. Dad told Skip during one of his projects "Read the book!", he never stopped, and continues to amaze us with his vast knowledge and capabilities.

Fred III (Rick) a few years older than Skip; spent some years in the Army where he became a medic attached to a helicopter outfit. After an honorable discharge he pursued some college, became a manager of an ambulance company and rescue team; an EMT, certified parachute rigger, skydiver, and a certified scuba diver. All these great accomplishments couldn't support his life style so he decided that he would give Dad another chance. Rick, besides being loquacious, is a very ingenious sewing machine operator and is responsible for many fixtures and special procedures.

Our Dad Passed Away February 2002

" We miss him terribly! "

Kimberly (Kimmy) I'm much younger than my brothers, but in 1988 I joined them at *Electron* after working several years at JFK International Airport as an Import Manager. One of my jobs at *Electron* was to put this story together. It was enjoyable, but not nearly as much fun as greeting customers on the phone and managing the office. Each month I spend quite a bit of time putting the newsletter together which we try to mail monthly.

Dad was inducted into our industry's "**HALL OF FAME**" in 1986 and retired at the end of 1987. He spent most of his spare time flying Radio Controlled Model Airplanes with a bunch of very active Seniors. Dad and Mom spent most of their later years driving together between their different houses enjoying the company of wonderful friends in each location.

"*WE*" were always delighted when Dad visited with us at the shop and joined in the discussions. "*WE*" derived a great deal of support from him as he shared his 53 years of experience in the Auto Trim Trade. Dad gave us the Motto, "**Our Reputation is Tops!**". He said that he saw it on a truck that did kitchen counters. It makes no difference because it has become our incentive and responsibility.

Mom has recently joined us in the office. Its exciting to have her here. She was always at Dads side during the birth and raising of *Electron* and ballast for us kids at home while Dad was busy with the company. She has seen *Electron Top* grow from the beginning.

"*WE*" are proud of our Dad and Grandfather; who gave us a strong foundation upon which to build, with strong principles and skills to use as tools.

"*WE* are not the beginning, nor the end."

Dad with the  Girls.



Electron Tops WARRANTY

Convertible tops - made out of American vinyl materials carry a 72 month warranty when installed on power operated frames and 48 months on manually operated frames. Tops with built in glass or vinyl back windows made in Vinyl, Stayfast, Topline or Sonnenland materials, carry a 48 month warranty on both power and manually operated frames. This does not include the plastic or vinyl window.

Economy tops - Ch4945, Fo4260, Fo4310 and Mz8340 made out of Haartz vinyl material, Stayfast or Topline carry a 36 month warranty. This does not include the plastic or vinyl window.

Glass window assemblies - carry a 60 month warranty against delamination of the bond between the glass and the material.

All warranties - stated herein are not transferable and only apply to the original purchaser's vehicle on which the product was installed. Installation of an *Electron Top* product constitutes acceptance of its warranty.

Electron Top's warranty covers the following:

- * Delamination or failure of heat sealed deck seams
- * Excessive shrinkage over 4%.
- * Delamination of the bond between the glass and the material for 60 months to the original purchaser.
- * Bad or cut stitching, or any other visible damage before installation has started.
- * Flows, mars or pits in vinyl materials before installation has started.
- * Zippers, fasteners, hardware or plastic parts before installation has started.
- * Gross weave problems in canvas longer than 3/8" (small ones are acceptable by OEM).
- * Major glass distortions before installation has started.

Electron Top is unable to warranty any product due to or for the following conditions:

- * Acts of God or vandalism.
- * Bad frame design, misaligned or malfunctioning frames.
- * Wear, pinch holes, fading or shrinkage of material under 4%.
- * Visible flaws, tears, blemishes, cut stitches or other noticeable faults after the start of installation.
- * Altering *Electron Top* product in any manner without our written consent including window tinting.
- * Accident, misuse, negligence or bad installation.
- * Use for other than private usage (commercial or rental).
- * Broken or cracked glass, bad defroster lines and/or tabs after the start of installation.
- * Vinyl windows cracking, scratching or uv degrading after the start of its installation.
- * Zippers, fasteners, hardware or plastic parts after the start of installation.
- * Installation by other than a professional upholstery shop.
- * The use of any citrus, petroleum or abrasive cleaners not recommended by the manufacturers of the material.
- * Products not manufactured by *Electron Top*.
- * Shade differences due to unavoidable pattern directional layouts.
- * Installation of any non O.E.M. accessory or conversion.
- * *Electron Top* "Classic Top" label has been removed.
- * *Electron Top* is not responsible for the way in which our products are installed by the installer.

The use of *Electron Top* products constitutes the buyer's understanding that: *Electron Top* cannot be held responsible for any collateral liabilities arising out of the use of its products. Furthermore, there are no additional warranties expressed or implied beyond what is described in our catalog's published warranty.

Should a Top or Glass Assembly Prove Defective - within the first 12 months, the product will be replaced. After the first year we will prorate the item. We reserve the right to request photographs of the installation prior to removal. Complete failure of the glass bond constitutes a warranty and replacement of the glass assembly without being prorated. Replacement of a product does not extend the original warranty of the item being replaced. *Electron Top* will be held harmless for any loss of time, revenue or consequential damages from the use of its products. Our registration number must be present on the label.

Labor - Installation of an *Electron Top* product constitutes registration of the warranty. In the unlikely event a claim is made, we will require proof of purchase (a photocopy of the original invoice). If a top or glass assembly has proven to be defective within the first year, we will issue a standard labor credit (you can call to confirm the offered labor). There will not be any labor credit issued after 12 months.

Labor credits are at *Electron Top's* sole discretion and are issued as a direct credit to the installer of the replacement in the form of another *Electron Top* product (another top, glass assembly, etc.). *WE* reserve the right to repair or replace a product with another like or reconditioned product at our discretion.

RETURN POLICY

Please call before returning any item. Items that have not been installed must be returned in the original packaging, folded in the original manner and taking extreme care of the vinyl windows, if any. *WE* take special care in the packaging of our products when we ship them, please return them in the same way. *WE* cannot accept any returns over 60 days from date of sale, except by special arrangement. Returns damaged by improper repacking will not be credited and will be returned to the customer. All applicable returns will be inspected before credit is issued and may be subject to a 15% restocking charge. *WE* will be unable to credit any item damaged, due to poor repacking. Cut Yardage of Material and Special Orders are not returnable.

"Our Reputation is Tops!"

YEAR	CAR IDENTIFICATION	Stock Number	Bow Height	Approx Installation Time
	<i>Electron</i>			
		US Dollars		
	<i>Suggested price for these materials</i>			
1965-66	Convertible Top Vinyl Curtain with Zipper Front Pad Set 66" Well Black (Call for Price on Colored or Different Materials) Cables Glass Window Tinted Suggested Color OE02 OE09 TR01 TR01	\$ 100.00 \$ 50.00 \$ 50.00 \$ 50.00 \$ 50.00 \$ 100.00	GM 0000 ET 0000	00 " 3.0
	<i>Use Add Box or Call when you don't find material listed on this line!</i>			
	* Pricing below is for tops only not accessories *			

Materials Other than Listed Above or Below, Please Call for Availability and Prices.

Add
 for Oe01 or Oe02
 Black Lining \$ 44.00

***Add* for Oe or Sa**
 Materials Not Listed Above
 and/or W/Tan Lining \$ 100.00

Add
 For Stayfast or Topline
 St11 and St14 Only \$ 340.00

Add
 For Stayfast or Topline (St) Colors
 other than St11 and St14 \$ 410.00

126-15 89th Ave Richmond Hill N.Y. 11418

* Prices subject to change without notice, Call for Latest Price *

1-(800) 221-4476

Universal Glass

** Caution, Glass Must Be Unzipped Prior to Folding **



We manufacture a universal glass which can be used with our GM3070 & GM3660 top. The glass may need alterations to align the bottom of the assembly to the tacking strip. Depending on the application, the material surrounding the glass may show from the outside of the vehicle. We used a black top over a white glass to illustrate this. Please advise your customer, this glass does not carry a warranty or guarantee.



"Family owned third generation."



"We Keep in Touch!"

"Our Reputation is Tops !"

		Suggested Price	Suggested Price
Cleaners & Protectants			
Wolfsteins Convertible Top Cleaner	16 oz. bottle	\$ 18.00	
Wolfsteins RAGTOPP Vinyl Protectant	16 oz. spray	\$ 25.00	
Wolfsteins Vinyl Care Kit	2 pc.	\$ 46.00	
Wolfsteins RAGTOPP Fabric Protectant	14 oz. spray	\$ 30.00	
Wolfsteins Fabric Care Kit	2 pc.	\$ 46.00	
Wolfsteins Leather Care Kit	2 pc.	\$ 54.00	
Wolfsteins Convertible Top Cleaning Brush	1 pc.	\$ 19.50	
Wolfsteins Vinyl Window Cleaning Kit	1 box	\$ 42.00	
Imar Vinyl Window Cleaner	16 oz. spray	\$ 27.00	
Imar Vinyl Window Polish	4 oz. bottle	\$ 8.00	
Zipper			
#10 Brass Chain Blk or Tan	per yard	\$ 8.50	
Slides Brass for Brass Chain	ea.	\$ 2.50	
#10, 60" Detachable Blk	ea.	\$ 13.25	
#10, 65" Detachable Blk or Tan	ea.	\$ 15.50	
End & Top Stops (Brass)	ea.	\$.25	
Extrusion w/Wire	ea.	\$ 9.00	
Slides Brass for Coil	ea.	\$ 2.50	
Zipper Option		\$ 100.00	
Zipper Plastic			
10mm 55" Coil Detachable	ea.	\$ 16.50	
10mm 55" Moulded Tooth	ea.	\$ 11.25	
8mm or 9mm Coil Chain	per yard	\$ 5.00	
Slides Black for Coil	ea.	\$ 2.50	
Vinyls Windows (40ga & 50ga, AS6 Approved)			
24" x 54" Clear	ea.	\$ 40.00	
24" x 54" Tinted (BMW green)	ea.	\$ 47.00	
29" x 68" Clear	ea.	\$ 50.00	
Shears			
10" Bent Trimmers Priced	per pair	\$135.00	
Glove Buttons			
Caps	Price per box 100	\$ 14.00	
Sockets	Price per box 100	\$ 12.00	
Studs	Price ea. .20 cents box 100	\$ 8.00	
Eyelets	Price ea. .20 cents box 100	\$ 8.00	
Tennax Fasteners (Cap & Plate)		\$ 12.00	
Tennax Studs Wood Screw	ea.	\$ 5.00	
Tennax Studs Metal Screw	ea.	\$ 5.00	
Classic Lincoln			
Glass & Frame (See Lincoln Page 52)	Request		
Speedy Tack			
Price	per can	\$ 40.00	
Thread (Dacron)			
Blk., White & Tan 16 oz	spool	\$ 88.00	
Bobbins	gross	\$ 94.00	
<i>Your regular discount does not apply to this page, please call for details.</i>			
Header Strips			
Uncovered - Black Rubber	ea.	\$ 13.00	
Cord Strips Top Material	ea.	\$ 12.00	
Round Rubber 3/8"	per yard	\$ 4.50	
Universal Cable			
9 ft with ferrules	ea.	\$ 24.00	
Tack Strips Plastic			
50 Ft Rolls R 3/8" x 1/2"		\$ 64.00	
50 Ft Rolls F 1/8" x 5/8"		\$ 64.00	
Webbing			
2" wide nylon webbing (Tan or Black)	per yard	\$ 5.50	
4" wide nylon webbing	per yard	\$ 7.50	
6" wide nylon webbing	per yard	\$ 9.00	
7 1/8" heavy cotton webbing	per yard	\$ 25.00	
9" wide nylon webbing	per yard	\$ 12.00	
Mercedes			
Window Profile	per yard	\$ 4.00	
Bow Listing	ea.	\$ 10.00	
Bow Sleeves			
Laminated Strips of German material	per strip	\$ 12.50	
Binding			
Vinyl 3/4" double fold	per yard	\$ 2.50	
Stayfast 3/4" double fold	per yard	\$ 4.00	
Wire-on			
Vinyl	per yard	\$ 6.50	
Stayfast	per yard	\$ 7.50	
End-tips	per pair	\$ 3.50	
Top Materials			
Bison IB	per yard	\$ 68.00	
Concord & OE	per yard	\$ 68.00	
Concord (Cn04 & Cn09)	per yard	\$ 80.00	
Eurotop Sailcloth or Pinpoint	per yard	\$ 84.00	
Honda Twill	per yard	\$ 80.00	
Hot Rod Colors	per yard	\$ 147.00	
Pigskin & Special Colors	per yard	\$ 72.00	
Sailcloth with Grey Lining	per yard	\$ 57.00	
Sonnendecke (StayfastG) & Topline G	per yard	\$ 162.00	
Sonnenland	per yard	\$ 273.00	
Stayfast & Topline (St01 to St22)			
Stayfast & Topline (St42 to St45)	per yard	\$ 120.00	
Trojan	per yard	\$ 57.00	
Twillfast (St23 to St41)	per yard	\$ 162.00	
Cut Charge on Convertible Top Materials less than 1 yd			
		\$ 10.00	
Cut Charge on (Binding, Wire-on, Cording) less than 30 yds			
		\$ 7.00	
Box Charge (items under \$25.00)			
		\$ 8.00	
Discounts Ten or more yards Full Roll no cutting			
		10% off	
		15% off	

126-15 89th Ave.
 Richmond Hill, N.Y. 11418
 Web Address www.electrontop.com

For Info Call (800) 221-4476
 Local (718) 846-7400
 To Fax (718) 846-8426
 E Mail info1@electrontop.com



YEAR	CAR IDENTIFICATION	List Price TR01 or TR02	Stock Number	Bow Height	Approx Installation Time
		US Dollars			
	AVANTI				
1987-89	II Convertible Vinyl Curtain Brass Zipper (Color matched)	\$ 475.00 \$ 210.00	AV 5030		
	BUICK				
1941-41	56c Super, 76c Roadmaster (2 Door) Double Blank Window Brass Zipper (When Purchased with the Top) Standard Universal Front & Rear Pad Set 75" Black Lining	\$ 525.00 \$ 230.00 \$ 128.00	GM 0060	18 ?	8 3
1941-41	44c Special, Series A Double Blank Window Brass Zipper (When Purchased with the Top) Standard Universal Front & Rear Pad Set 75" Black Lining	\$ 525.00 \$ 230.00 \$ 128.00	GM 0080	20 1/2"	8 3
1942-48	56c, 76c Roadmaster Vinyl Curtain Horseshoe Brass Zipper (Color Matched) Double Blank Window Brass Zipper (When Purchased with the Top) Standard Universal Front & Rear Pad Set 75" Black Lining	\$ 525.00 \$ 196.00 \$ 230.00 \$ 128.00	GM 0470	20 ?	8 2 3
1942-48	56c, 76c Roadmaster (CLASSIC TOP) St01 or St04 Double Blank Window Brass Zipper Standard Front & Rear Pad Set 75" (See Pad Pages) This top has all of the original details. The tops major seams are top stitched, there is a reinforced flap running down inside of each quarter to accept snaps and no side reinforcement stitch. The rear window opening runs straight up with a separate bound valance that forms the upper and is double blanked to accept a small glass and frame (supplied by customer). All bound edges are hand rolled and top stitched. The price includes, top, rear double blank curtain, and 4 piece pads.	\$ 1480.00 included included	GM 0473	20 ?	12
1949-49	All Models Vinyl Curtain Brass Horseshoe Zipper (Color Matched) Double Blank Window Brass Zipper (When Purchased with the Top) Standard Universal Front & Rear Pad Set 75" Black Lining	\$ 525.00 \$ 196.00 \$ 230.00 \$ 128.00	GM 0600	21 1/2"	8 2 3
1950-52	56c Super, 76c Roadmaster Vinyl Curtain Brass Horseshoe Zipper (Color Matched) Double Blank Window Brass Zipper (When Purchased with the Top) Standard Universal Front & Rear Pad Set 75" Black Lining Well Black (Cn08)	\$ 525.00 \$ 196.00 \$ 230.00 \$ 128.00 \$ 160.00	GM 1040	19 1/2"	8 2 3
1951-52	46c Special Vinyl Curtain Brass Horseshoe Zipper (Color Matched) Standard Universal Front & Rear Pad Set 75" Black Lining	\$ 525.00 \$ 196.00 \$ 128.00	GM 1370	19 1/2"	8 2

* Pricing below is for tops only not accessories *

Materials Other than Listed Above or Below, Please Call for Availability and Prices.

Add
for Oe01 or Oe02
Black Lining \$ 44.00*Add* for Oe or Sa
Materials Not Listed Above
and/or W/ Tan Lining \$ 100.00*Add*
For Stayfast or Topline
St11 and St14 Only \$ 340.00*Add*
For Stayfast or Topline (St) Colors
other than St11 and St14 \$ 410.00

"Our Reputation is Tops!"

YEAR	CAR IDENTIFICATION	List Price TR01 or TR02	Stock Number	Bow Height	Approx Installation Time
		US Dollars			
	Buick				
1953-53	46c Special Vinyl Curtain Horseshoe Brass Zipper (Color Matched) Standard Universal Front & Rear Pad Set 75" Black Lining	\$ 525.00 \$ 196.00 \$ 128.00	GM 1380	19 1/2"	8 2
1953-53	56c Super, 76c Roadmaster Vinyl Curtain Horseshoe Brass Zipper (Color Matched) Standard Universal Front & Rear Pad Set 75" Black Lining	\$ 525.00 \$ 196.00 \$ 128.00	GM 1390	18 3/4"	8 2
1953-53	Skylark Vinyl Curtain Horseshoe Brass Zipper (Color Matched) Standard Universal Front & Rear Pad Set 66" Black Lining	\$ 525.00 \$ 196.00 \$ 122.00	GM 1240	19 1/2"	8 2
1954-56	46c Special, 66c Century, 100 Skylark Vinyl Curtain Horseshoe Brass Zipper (Color Matched) Standard Universal Front & Rear Pad Set 75" Black Lining Well Black (Cn08)	\$ 525.00 \$ 196.00 \$ 128.00 \$ 160.00	GM 1460	19 1/2"	8 2
1954-56	56c Super, 76c Roadmaster Vinyl Curtain Horseshoe Brass Zipper (Color Matched) Standard Universal Front & Rear Pad Set 75" Black Lining Well Black (Cn08)	\$ 525.00 \$ 196.00 \$ 128.00 \$ 160.00	GM 1470	19 1/2"	8 2
1957-58	46c Special, 66c Century Vinyl Curtain Horseshoe Brass Zipper (Color Matched) Standard Universal Front & Rear Pad Set 75" Black Lining Well Black (Cn08)	\$ 450.00 \$ 196.00 \$ 128.00 \$ 160.00	GM 2030	19 1/4"	8 2
1957-58	56c Super, 75c, 76c Roadmaster Vinyl Curtain Horseshoe Brass Zipper (Color Matched) Standard Universal Front & Rear Pad Set 75" Black Lining Well Black (Cn08)	\$ 450.00 \$ 196.00 \$ 128.00 \$ 160.00	GM 2090	21 1/2"	8 2
1959-60	All Models Vinyl Curtain Horseshoe Brass Zipper (Color Matched) Standard Universal Front & Rear Pad Set 75" Black Lining Well Black (Cn08)	\$ 400.00 \$ 196.00 \$ 128.00 \$ 160.00	GM 2620	23"	8 2
1961-64	Invicta, LeSabre, Wildcat, Electra, (C Body) Vinyl Curtain Brass Zipper (No Bottom Strip) Spl Front Pad Set Black Lining Well Black (Cn08) Side Cables (See Cable Pages) Universal Glass Window Tinted (Not Warranted) Note: See Page 15 and Call For Details	\$ 324.00 \$ 182.00 \$ 79.00 \$ 142.00 \$ 116.00 \$ 380.00	GM 3070	25"	6 2
1962-63	Special, Skylark G.S. Vinyl Curtain Brass Zipper (No Bottom Strip) Standard Universal Front Pad Set 60" Black Lining Well Black (Cn08)	\$ 324.00 \$ 182.00 \$ 68.00 \$ 142.00	GM 3150	21 3/4"	6 2
1964-65	Special, Skylark G.S. Vinyl Curtain Brass Zipper (No Bottom Strip) Standard Universal Front Pad Set 60" Black Lining Well Black (Cn08) Side Cables (See Cable Pages)	\$ 324.00 \$ 182.00 \$ 68.00 \$ 142.00 \$ 60.00	GM 3410	20 1/2"	6 2

* Labor times are based on when the cars were new *

Materials Other than Listed Above or Below, Please Call for Availability and Prices.

Add
for Oe01 or Oe02
Black Lining \$ 44.00

***Add* for Oe or Sa**
Materials Not Listed Above
and/or W/ Tan Lining \$ 100.00

Add
For Stayfast or Topline
St11 and St14 Only \$ 340.00

Add
For Stayfast or Topline (St) Colors
other than St11 and St14 \$ 410.00

AVANTI
BUICK



Electron Top

YEAR	CAR IDENTIFICATION	List Price TR01 or TR02	Stock Number	Bow Height	Approx Installation Time
		US Dollars			
	Buick				
1965-70	LeSabre, Wildcat Vinyl Curtain Brass Zipper (No Bottom Strip) Standard Universal Front Pad Set 66" Black Lining Well Black (Cn08) Side Cables (See Cable Pages) Glass Window Tinted Zipper Glass Window Tinted Note: 1965 Model had a 58 1/2" Front Bow our Top is 1" Wider	\$ 324.00 \$ 182.00 \$ 70.00 \$ 142.00 \$ 50.00 \$ 320.00 \$ 330.00	GM 6571 ET 5000 ET 5009	27 1/2" 27 1/2" 21 3/4" 20 1/2"	6 2 3 3 6 2 6 2 3 3
1965-70	Electra 225 Vinyl Curtain Brass Zipper (No Bottom Strip) Standard Universal Front Pad Set 66" Black Lining Well Black (Cn08) Side Cables (See Cable Pages) Glass Window Tinted Zipper Glass Window Tinted Note: 1965 Model had a 58 1/2" Front Bow our Top is 1" Wider	\$ 324.00 \$ 182.00 \$ 70.00 \$ 142.00 \$ 50.00 \$ 320.00 \$ 330.00	GM 6572 ET 5000 ET 5009	27 1/2" 27 1/2" 21 3/4" 20 1/2"	6 2 3 3 6 2 6 2 3 3
1966-67	Special, Skylark G.S. Vinyl Curtain Brass Zipper (No Bottom Strip) Standard Universal Front Pad Set 60" Black Lining Side Cables (See Cable Pages) Well Black (Cn08) Universal Glass Window Tinted (Not Warranted) See Note Pg. 15 Note: See Page 15 and Call For Details	\$ 324.00 \$ 182.00 \$ 68.00 \$ 56.00 \$ 142.00 \$ 380.00	GM 3660 ET 1720	21 3/4" 20 1/2"	6 2 3
1968-72	Special, Skylark, G.S. Vinyl Curtain No Zipper (No Bottom Strip) Spl Front Pad Set Black Lining Well Black (Cn08) Side Cables (See Cable Pages) Glass Window Tinted Glass Window Tinted With Zipper Suggested Color OE02 TR01 TR02	\$ 324.00 \$ 182.00 \$ 79.00 \$ 142.00 \$ 56.00 \$ 320.00 \$ 330.00	GM 3680 ET 5020 ET 5029	20 1/2"	6 2 3 3



GM 6572 Top

**Compliments of
Kenny
Convertible Top Man
GA.
Buick Electra 225**

* Pricing below is for tops only not accessories *

Materials Other than Listed Above or Below, Please Call for Availability and Prices.

Add for Oe01 or Oe02 Black Lining \$ 44.00	*Add* for Oe or Sa Materials Not Listed Above and/or W/ Tan Lining \$ 100.00	*Add* For Stayfast or Topline St11 and St14 Only \$ 340.00	*Add* For Stayfast or Topline (St) Colors other than St11 and St14 \$ 410.00
--	--	--	--

"Our Reputation is Tops!"

YEAR	CAR IDENTIFICATION	List Price TR01 or TR02	Stock Number	Bow Height	Approx Installation Time
	Buick	US Dollars			
1971-75	Electra, LeSabre, Centurion Vinyl Curtain Plastic Zipper (Color Matched) Spl Webbing Front Pad Set Webbing is 38" Long (See Pad Pages) Well Black (Cn08) Raingutter (Tr01) Original Style Cables for (1971 Only (See Cable Pages) Universal Cables (1972-76 Only)-(See Cable Pages) Original Style Cables Sold in a Set (Left & Right - See Cable Pages) Glass Window Tinted Glass Window Tinted W/Defroster Glass Curtain Clips for Control Arm Suggested Color OE02 TR01 TR02	\$ 324.00 \$ 230.00 \$ 80.00 \$ 142.00 \$ 100.00 \$ 116.00 \$ 60.00 \$ 116.00 \$ 360.00 \$ 420.00 \$ 75.00	GM 4730 ET 5040t ET 5040h	26" 3 3	8 3
1982-86	Riviera (A.S.C. Conversion) Vinyl Curtain Brass Zipper (Color Matched) 9" Webbing Pads 60" Long (See Pad Pages) Side Cables (See Cable Pages) Glass Window Tinted Glass Window Tinted W/Defroster Headliner Available in Blk, Taupe, and Bordeaux Suggested Color TR01 TR02	\$ 324.00 \$ 196.00 \$ 34.00 \$ 46.00 \$ 340.00 \$ 400.00 \$ 495.00	GM 4880 ET 5050t ET 5050h	16 1/2" 3 3	8 2
1990-91	Reatta (Glass Curtain Model) (A.S.C. Conversion) Glass Window is sealed into top - Heated Glass Headliner Available in Black Please Allow 4-5 Days for Manufacturing Suggested Color TR01 TR02 OE03	\$ 990.00 included \$ 495.00	GM 4950		9.5
1990-91	Reatta (Vinyl Curtain Model) (A.S.C. Conversion) Vinyl Window is sealed into top Headliner Available in Black Please Allow 4-5 Days for Manufacturing Suggested Color TR01 TR02 OE03	\$ 760.00 \$ 495.00	GM 4955		9.5

BUICK



GM 3680 Top

**Compliments of
Kenny
The Convertible Top Man GA.
Olds 442**

* Labor times are based on when the cars were new *

Materials Other than Listed Above or Below, Please Call for Availability and Prices.

***Add*
for Oe01 or Oe02
Black Lining \$ 44.00**

***Add* for Oe or Sa
Materials Not Listed Above
and/or W/ Tan Lining \$ 100.00**

***Add*
For Stayfast or Topline
St11 and St14 Only \$ 340.00**

***Add*
For Stayfast or Topline (St) Colors
other than St11 and St14 \$ 410.00**



Electron Top

YEAR	CAR IDENTIFICATION	List Price TR01 or TR02	Stock Number	Bow Height	Approx Installation Time
	CADILLAC	US Dollars			
1941-41	All Models (2 Door) Double Blank Window Brass Zipper (When Purchased with the Top) Standard Universal Front & Rear Pad Set 75" Black Lining	\$ 525.00 \$ 230.00 \$ 128.00	GM 0060	18 ?	8 3
1942-47	All Models Vinyl Curtain Horseshoe Brass Zipper (Color Matched) Double Blank Window Brass Zipper (When Purchased with the Top) Standard Universal Front & Rear Pad Set 75" Black Lining	\$ 525.00 \$ 196.00 \$ 230.00 \$ 128.00	GM 0470	20 ?	8 2 3
1942-47	All Models CLASSIC TOP St01 or St04 Double Blank Window is Material Matched Standard Front & Rear Pad Set 75" (See Pad Pages) This top has all of the original details. The tops major seams are top stitched, there is a reinforced flap running down inside of each quarter to accept snaps, and no side reinforcement stitch. The rear window opening runs straight up with a separate bound valance that forms the upper window opening. The rear curtain is double blanked with two zippers if you have the plate that screws to the rear bow. If you do not have the rear bow plate please let us know we will make you a double blank curtain with 3 zippers. Either way the rear curtain is set up to accept a small glass and frame (supplied by your customer). All bound edges are hand rolled and top stitched. The price includes, top, rear double blank curtain, and 4 piece pads.	\$ 1480.00 included included	GM 0473	20 ?	8
1948-49	All Models Vinyl Curtain Horseshoe Brass Zipper (Color Matched) Double Blank Window Brass Zipper (When Purchased with the Top) Standard Universal Front & Rear Pad Set 75" Black Lining	\$ 525.00 \$ 196.00 \$ 230.00 \$ 128.00	GM 0600	21 1/2?	8 2 3
1950-52	All Models Vinyl Curtain Horseshoe Brass Zipper (Color Matched) Double Blank Window Brass Zipper (When Purchased with the Top) Standard Universal Front & Rear Pad Set 75" Black Lining Well Black (Cn08)	\$ 525.00 \$ 196.00 \$ 230.00 \$ 128.00 \$ 160.00	GM 1040	19 1/2?	8 2 3
1953-53	Eldorado Only Vinyl Window part of top Standard Universal Front & Rear Pad Set 75" Black Lining	\$ 525.00 included \$ 128.00	GM 1060	19 ?	8
1953-53	All Models (Except Eldorado) Vinyl Curtain Horseshoe Brass Zipper (Color Matched) Standard Universal Front & Rear Pad Set 75" Black Lining	\$ 525.00 \$ 196.00 \$ 128.00	GM 1390	18 3/4?	8 2
1954-56	All Models Vinyl Curtain Horseshoe Brass Zipper (Color Matched) Standard Universal Front & Rear Pad Set 75" Black Lining Well Black (Cn08)	\$ 525.00 \$ 196.00 \$ 128.00 \$ 160.00	GM 1470	19 1/2"	8 2
1957-58	All Models Vinyl Curtain Horseshoe Brass Zipper (Color Matched) Standard Universal Front & Rear Pad Set 75" Black Lining Well Black (Cn08)	\$ 450.00 \$ 196.00 \$ 128.00 \$ 160.00	GM 2090	21 1/2"	8 2
1959-60	All Models Vinyl Curtain Horseshoe Brass Zipper (Color Matched) Standard Universal Front & Rear Pad Set 75" Black Lining Well Black (Cn08)	\$ 400.00 \$ 196.00 \$ 128.00 \$ 160.00	GM 2620	23 "	8 2

* Pricing below is for tops only not accessories *

Materials Other than Listed Above or Below, Please Call for Availability and Prices.

Add
for Oe01 or Oe02
Black Lining \$ 44.00

***Add* for Oe or Sa**
Materials Not Listed Above
and/or W/ Tan Lining \$ 100.00

Add
For Stayfast or Topline
St11 and St14 Only \$ 340.00

Add
For Stayfast or Topline (St) Colors
other than St11 and St14 \$ 410.00

"Our Reputation is Tops!"

CADILLAC

YEAR	CAR IDENTIFICATION	List Price TR01 or TR02	Stock Number	Bow Height	Approx Installation Time
	Cadillac	US Dollars			
1961-64	All Models (C Body)	\$ 324.00	GM 3070	25 "	6
	Vinyl Curtain Brass Zipper (No Bottom Strip)	\$ 182.00			2
	Spl Front Pad Set	\$ 79.00			
	Well Black	\$ 142.00			
	Side Cables (See Cable Pages)	\$ 116.00			
	Universal Glass Window Tinted (Not Warranted) See Note Pg. 15	\$ 380.00	ET 1730		3
	Note: See Page 15 and Call For Details				
1965-70	All Models	\$ 324.00	GM 6572	27 1/2"	6
	Vinyl Curtain Brass Zipper (No Bottom Strip)	\$ 182.00			2
	Standard Universal Front Pad Set 66"	\$ 70.00			
	Well Black	\$ 142.00			
	Side Cables (See Cable Pages)	\$ 50.00			
	Glass Window Tinted	\$ 320.00	ET 5000		3
1965-66	Zipper Glass Window Tinted	\$ 330.00	ET 5009		3
	Note: 1965 Model had a 58 1/2" Front Bow our Top is 1" Wider				
1971-76	All Models	\$ 324.00	GM 4730	26"	8
	Vinyl Curtain Plastic Zipper (Color Matched)	\$ 230.00			3
	Spl Webbing Front Pad Set Webbing is 38" Long (See Pad Pages)	\$ 80.00			
	Well Black	\$ 142.00			
	Raingutter	\$ 100.00			
	Original Style Cables for (1971 Only - See Cable Pages)	\$ 116.00			
	Universal Cables (1972-76 Only - See Cable Pages)	\$ 60.00			
	Original Style Cables Sold in a Set (Left & Right - See Cable Pages)	\$ 116.00			
	Glass Window Tinted	\$ 360.00	ET 5040t		3
	Glass Window Tinted W/Defroster	\$ 420.00	ET 5040h		3
	Glass Curtain Clips for Control Arms	\$ 75.00			
	Suggested Color OE02 TR01 TR02				
1982-86	Eldorado (A.S.C. Conversion)	\$ 324.00	GM 4880	16 1/2"	8
	Vinyl Curtain Brass Zipper (Color Matched)	\$ 196.00			2
	9" Webbing Pads 60" Long (See Pad Pages)	\$ 34.00			
	Side Cables (See Cable Pages)	\$ 46.00			
	Glass Window Tinted	\$ 340.00	ET 5050t		3
	Glass Window Tinted W/Defroster	\$ 400.00	ET 5050h		3
	Headliner Available in Black, Taupe, and Bordeaux	\$ 495.00			
	Suggested Color TR01 TR02				



**Compliments of
Kenny
Convertible Top Man, GA.
1968 Cadillac**

* Labor times are based on when the cars were new *

Materials Other than Listed Above or Below, Please Call for Availability and Prices.

Add
for Oe01 or Oe02
Black Lining \$ 44.00

***Add* for Oe or Sa**
Materials Not Listed Above
and/or W/ Tan Lining \$ 100.00

Add
For Stayfast or Topline
St11 and St14 Only \$ 340.00

Add
For Stayfast or Topline (St) Colors
other than St11 and St14 \$ 410.00



Electron Top

YEAR	CAR IDENTIFICATION	List Price TR01 or TR02	Stock Number	Bow Height	Approx Installation Time
		US Dollars			
	CHEVROLET	Corvettes listed separately on page 35			
1941-41	All Models Double Blank Window Brass Zipper (When Purchased with the Top) Standard Universal Front & Rear Pad Set 75" Black Lining	\$ 525.00 \$ 230.00 \$ 128.00	GM 0080	20 1/2"	8 3
1942-48	All Models Vinyl Curtain Brass Zipper (Color Matched) Double Blank Window Brass Zipper (When Purchased with the Top) Standard Universal Front & Rear Pad Set 75" Black Lining	\$ 525.00 \$ 196.00 \$ 230.00 \$ 128.00	GM 0090	20 1/2"	8 2 3
1949-49	All Models Vinyl Curtain Brass Zipper (Color Matched) Double Blank Window Brass Zipper (When Purchased with the Top) Standard Universal Front & Rear Pad Set 75" Black Lining	\$ 525.00 \$ 196.00 \$ 230.00 \$ 128.00	GM 0960	21 1/2"	8 2 3
1950-52	All Models Vinyl Curtain Brass Zipper (Color Matched) Double Blank Window Brass Zipper (When Purchased with the Top) Standard Universal Front & Rear Pad Set 75" Black Lining	\$ 525.00 \$ 196.00 \$ 230.00 \$ 128.00	GM 0970	20 1/2"	8 2 3
1953-54	All Models Vinyl Curtain Brass Zipper (Color Matched) Standard Universal Front & Rear Pad Set 66" Black Lining	\$ 525.00 \$ 196.00 \$ 122.00	GM 1360	20 1/2"	8 2
1955-57	All Models Vinyl Curtain Brass Zipper (Color Matched) Standard Universal Front & Rear Pad Set 75" Well Black Black Lining (Cn08)	\$ 450.00 \$ 196.00 \$ 128.00 \$ 160.00	GM 1610	20 1/2"	8 2
1958-58	Impala Vinyl Curtain Brass Zipper (Color Matched) Standard Universal Front & Rear Pad Set 75" Black Lining	\$ 450.00 \$ 196.00 \$ 128.00	GM 2250	22"	8 2
1959-60	Impala Vinyl Curtain Brass Zipper (Color Matched) Standard Universal Front & Rear Pad Set 75" Well Black Black Lining (Cn08)	\$ 400.00 \$ 196.00 \$ 128.00 \$ 160.00	GM 2620	23"	8 2
1961-64	Impala Vinyl Curtain Brass Zipper (No Bottom Strip) Spl Front Pad Set Black Lining (Cn08) Well Black Cables (See Cable Pages) Universal Glass Window Tinted (Not Warranted) See Note Note: See Page 15 and Call For Details	\$ 324.00 \$ 182.00 \$ 79.00 \$ 142.00 \$ 116.00 \$ 380.00	GM 3070	25"	6 2 3
1962-63	Chevy II, Nova 400 Vinyl Curtain Brass Zipper (No Bottom Strip) Standard Universal Front Pad Set 66" Black Lining (Cn08) Cables (See Cable Pages) Nova Only Well Black	\$ 324.00 \$ 182.00 \$ 70.00 \$ 116.00 \$ 142.00	GM 3220	21"	6 2
1962-64	Corvair, Monza, Corsa Vinyl Curtain Brass Zipper (No Bottom Strip) Standard Universal Front Pad Set 60" Black Lining (Cn08) Well Black	\$ 324.00 \$ 182.00 \$ 68.00 \$ 142.00	GM 3240	22 1/2"	6 2

* Pricing below is for tops only not accessories *

Materials Other than Listed Above or Below, Please Call for Availability and Prices.

Add
for Oe01 or Oe02
Black Lining \$ 44.00*Add* for Oe or Sa
Materials Not Listed Above
and/or W/ Tan Lining \$ 100.00*Add*
For Stayfast or Topline
St11 and St14 Only \$ 340.00*Add*
For Stayfast or Topline (St) Colors
other than St11 and St14 \$ 410.00

YEAR	CAR IDENTIFICATION	List Price TR01 or TR02	Stock Number	Bow Height	Approx Installation Time
	Chevrolet	US Dollars			
1964-65	Chevelle, Malibu Vinyl Curtain Brass Zipper (No Bottom Strip) Standard Universal Front Pad Set 60" Side Cables Well Black	\$ 324.00 \$ 182.00 \$ 68.00 \$ 60.00 \$ 142.00	GM 3410	20 1/2"	6 2
	Black Lining (Cn08)				
1965-69	Corvair, Monza, Corsa Vinyl Curtain Brass Zipper (No Bottom Strip) Standard Universal Front Pad Set 60" Well Black	\$ 324.00 \$ 182.00 \$ 68.00 \$ 142.00	GM 3260	20 3/4"	6 2
	Black Lining (Cn08)				
1965-70	Impala, Super Sport, Bellaire Vinyl Curtain Brass Zipper (No Bottom Strip) Standard Universal Front Pad Set 66" Well Black Side Cables (See Cable Pages) Glass Window Tinted	\$ 324.00 \$ 182.00 \$ 70.00 \$ 142.00 \$ 50.00 \$ 320.00	GM 6571	27 1/2"	6 2
1965-66	Zipper Glass Window Tinted	\$ 330.00	ET 5000 ET 5009		3 3
1966-67	Chevelle, Malibu Vinyl Curtain Brass Zipper (No Bottom Strip) Standard Universal Front Pad Set 60" Side Cables (See Cable Pages) Well Black Universal Glass Window Tinted (Not Warranted) See Note Pg. 15 Note: See Page 15 and Call For Details	\$ 324.00 \$ 182.00 \$ 68.00 \$ 56.00 \$ 142.00 \$ 380.00	GM 3660	21 3/4"	6 2
	Black Lining (Cn08)		ET 1720		3
1967-69	Camaro (Vinyl Curtain Model) Vinyl Curtain (No bottom strip) No Zipper Vinyl Curtain (No bottom strip) With Brass Zipper (Non-original) Standard Universal Front Pad Set 60" Well Black Side Cables (See Cable Pages) Note: For Glass Window Use GM 3740	\$ 324.00 \$ 182.00 \$ 196.00 \$ 68.00 \$ 142.00 \$ 64.00	GM 3720	22 1/2"	6 2
	Black Lining (Cn08)				
1967-69	Camaro (Glass Curtain Model) Standard Universal Front Pad Set 60" Well Black Side Cables (See Cable Pages) Note: Glass Window Tinted (Non Hinged Glass) Note: Uses glass from Et2570 Note: (Glass window is not warranteed) *Call for details	\$ 370.00 \$ 68.00 \$ 142.00 \$ 64.00 \$ 400.00	GM 3740	22 1/2"	7
	Black Lining (Cn08)		ET 2490		3
1968-72	Chevelle, Malibu, SS 396 Vinyl Curtain No Zipper (No Bottom Strip) Spl Front Pad Set Well Black Side Cables (See Cable Pages) Glass Window Tinted Glass Window Tinted With Brass Zipper Suggested Color OE02 TR01 TR02	\$ 324.00 \$ 182.00 \$ 79.00 \$ 142.00 \$ 56.00 \$ 320.00 \$ 330.00	GM 3680	20 1/2"	6 2
	Black Lining (Cn08)		ET 5020 ET 5029		3 3

* Labor times are based on when the cars were new *

Materials Other than Listed Above or Below, Please Call for Availability and Prices.

Add
for Oe01 or Oe02
Black Lining \$ 44.00

***Add* for Oe or Sa**
Materials Not Listed Above
and/or W/ Tan Lining \$ 100.00

Add
For Stayfast or Topline
St11 and St14 Only \$ 340.00

Add
For Stayfast or Topline (St) Colors
other than St11 and St14 \$ 410.00

"Our Reputation is Tops!"

YEAR	CAR IDENTIFICATION	List Price TR01 or TR02	Stock Number	Bow Height	Approx Installation Time
		US Dollars			
	Camaro				
1987-88	Camaro (A.S.C.) * You Must ID Top with Diagram Below * 9" Webbing Pads 60" (See Pad Pages) Side Cables (See Cable Pages) Note: (Frames have an issue that can damage the top.) Suggested Color St11 Tr01	\$ 475.00 \$ 34.00 \$ 58.00	GM 3820		6
1988-91	Camaro (A.S.C.) * You Must ID Top with Diagram Below * 9" Webbing Pads 60" (See Pad Pages) Side Cables (See Cable Pages) Note: (Frames have an issue that can damage the top.) Suggested Color St11 Tr01	\$ 475.00 \$ 34.00 \$ 58.00	GM 3830		6
1990-93	Camaro (A.S.C.) * You Must ID Top with Diagram Below * 9" Webbing Pads 60" (See Pad Pages) Headliner Available in Black Cloth, (Two Pieces) Side Cables (See Cable Pages) Note: (Frames have an issue that can damage the top.) Suggested Color St11 Tr01	\$ 475.00 \$ 34.00 \$ 346.00 \$ 58.00	GM 3850		6
<div style="border: 3px double black; padding: 10px;"> <p>Note:</p> <p>1987-89 GM3820 - under 51" binding to binding Center deck measure about 41" just in front of rear bow.</p> <p>1988-91 GM 3830 - over 51 1/2" binding to binding Center deck measure about 41" just in front of rear bow.</p> <p>1990-93 GM 3850 - over 50 1/2" under 52" binding to binding Center deck measure about 44" just in front of rear bow.</p> </div>					
1994-04	Camaro Suggested Retail Suggested Retail Vinyl Curtain (Color Matched) Glass Window Tinted Only Glass Window Tinted W/Defroster 6" Webbing Front Pad Set 55" Side Cables (See Cable Pages - Please order 23" or 29") Headliner Now Available Black Cloth (One Piece) Note: Extrusion to be transferred to new headliner from old Suggested Color St11 St14 St21 Ts20 Original Material 1994-04 Pinpoint Vinyl & Stayfast	\$ 360.00 \$ 420.00 \$ 600.00 \$ 196.00 \$ 366.00 \$ 430.00 \$ 28.00 \$ 58.00 \$ 345.00	GM 3860 ET 3860t ET 3860h	23 "	7 2 3 3
2011-13	Camaro	Call			

* Labor times are based on when the cars were new *

Materials Other than Listed Above or Below, Please Call for Availability and Prices.

Add
 for Oe01 or Oe02
 Black Lining \$ 44.00

***Add* for Oe or Sa**
 Materials Not Listed Above
 and/or W/ Tan Lining \$ 100.00

Add
 For Stayfast or Topline
 St11 and St14 Only \$ 340.00

Add
 For Stayfast or Topline (St) Colors
 other than St11 and St14 \$ 410.00





YEAR	CAR IDENTIFICATION	List Price TR01 or TR02	Stock Number	Bow Height	Approx Installation Time
		US Dollars			
	Chevrolet				
1983-87	Cavalier Vinyl Curtain (Color Matched) 9" Webbing Pads 55" (See Pad Pages) Side Cables (See Cable Pages) Rear Quarter Cables (See Cable Pages) Well Black Suggested Color Oe02 Oe11 Tr01 Tr02	\$ 324.00 \$ 196.00 \$ 28.00 \$ 58.00 \$ 58.00 \$ 160.00	GM 4870	21 1/2"	6 2
1988-92?	Cavalier (Wireon on Rear Bow) Vinyl Curtain (No Bottom Strip) 9" Webbing Pads 60" (See Pad Pages) Side Cables (See Cable Pages) Rear Quarter Cables (See Cable Pages) Well Black Note: Top was used for earlier production in 1992. Bow height is from bottom tack rail to middle of top bow. Suggested Color Oe02 Oe11 Oe16 Tr01 Tr02	\$ 324.00 \$ 182.00 \$ 34.00 \$ 58.00 \$ 58.00 \$ 160.00	GM 4910	26 1/4"	6 2
1992-93?	Cavalier (Top Wraps Around Front Header Bow) Vinyl Curtain (Color Matched) 9" Webbing Pads 60" (See Pad Pages) Rear Webbing Pads With Elastic Part of Top Side Cables (See Cable Pages) Rear Quarter Cables (See Cable Pages) Well Black Glass Window Tinted Glass Window Tinted W/Defroster Note: Glass is Attached to Rear Bow with Extrusion Suggested Color Tr01 Tr02	\$ 324.00 \$ 196.00 \$ 34.00 included \$ 58.00 \$ 58.00 \$ 160.00 \$ 310.00 \$ 380.00	GM 4970	27 "	6.5 3 3 3
1993-94	Cavalier (Front Bow Pocket, White Top has Black Binding) Ts20 Note: Top is Bound Across Front Bow Vinyl Curtain (Color Matched) uses a GM 4970 Vinyl 9" Webbing Pads 60" (See Pad Pages) Rear Webbing Pads With Elastic Part of Top Side Cables (See Cable Pages) Rear Quarter Cables (See Cable Pages) Well Black Glass Window Tinted Glass Window Tinted W/Defroster Note: Glass is Attached to Rear Bow with Extrusion Suggested Color Tr01 Tr02 Ts20 Original Material Pinpoint Vinyl	\$ 324.00 \$ 400.00 \$ 196.00 \$ 34.00 included \$ 58.00 \$ 58.00 \$ 160.00 \$ 310.00 \$ 380.00	GM 5060	27 "	6.5 3 3 3
	GEO				
	See Sport Utility Vehicles Page 68				
1988-02	Geo Tracker				
1990-94	Geo Metro or Firefly Vinyl Window Part of Top Side Cables (See Cable Pages) Suggested Color Tr01	\$ 420.00 included \$ 68.00	GM 5100		6

* Pricing below is for tops only not accessories *

Materials Other than Listed Above or Below, Please Call for Availability and Prices.

Add
for Oe01 or Oe02
Black Lining \$ 44.00*Add* for Oe or Sa
Materials Not Listed Above
and/or W/ Tan Lining \$ 100.00*Add*
For Stayfast or Topline
St11 and St14 Only \$ 340.00*Add*
For Stayfast or Topline (St) Colors
other than St11 and St14 \$ 410.00

YEAR	CAR IDENTIFICATION	List Price TR01 or TR02	Stock Number	Bow Height	Approx Installation Time
Chevrolet		US Dollars			
		<div style="border: 2px solid black; padding: 5px;"> <p>Compliments of Kenny Convertible Top Man, GA. 1992 Chevrolet Cavalier</p> </div>			
1995-98	Cavalier (White Top has Black Binding)	Tr01 Ts20	GM 5070	27 1/2"	6.5
	Vinyl Curtain Extrusion (Color Matched)	\$ 324.00			
	6" Webbing Pads 60" (See Pad Pages)	\$ 400.00			
	Rear Webbing Pads Part of Top	\$ 196.00			3
	Side Cables (See Cable Pages)	\$ 30.00			
	Rear Quarter Cables	included			
	Headliner Available in Graphite	\$ 70.00			
	Glass Window Tinted	\$ 58.00			
	Glass Window Tinted W/Defroster	\$ 345.00			
	Note: Attached to Rear Bow With Extrusion	\$ 310.00	ET 5070t		3
	Original Material 1995-97 Pinpoint Vinyl	\$ 380.00	ET 5070h		3
	Note: See Manufacturers TSB'S on our Website				
1999-00	Cavalier (White Top has Black Binding)	Sa13 Se27 or Se28	GM 5090	27 1/2?"	6
	Vinyl Curtain (Color Matched)	\$ 324.00			
	6" Webbing Pads 60"	\$ 400.00			
	Rear Webbing Pads Part of Top	\$ 196.00			
	Side Cables (See Cable Pages)	\$ 30.00			
	Headliner Available in Graphite	included			
	Glass Window Tinted,	\$ 70.00			
	Glass Window Tinted W/Defroster	\$ 345.00			
	Note: Attached to Rear Bow With Extrusion	\$ 310.00	ET 5070t		3
	Original Material Sailcloth Vinyl	\$ 380.00	ET 5070h		3
	Note: See Manufacturers TSB'S on our Website				
		<div style="border: 2px solid black; padding: 5px;"> <p>Compliments of Kenny Convertible Top Man, GA. 1996 Chevrolet Cavalier</p> </div>			

* Labor times are based on when the cars were new *

Materials Other than Listed Above or Below, Please Call for Availability and Prices.

Add
for Oe01 or Oe02
Black Lining \$ 44.00

***Add* for Oe or Sa**
Materials Not Listed Above
and/or W/ Tan Lining \$ 100.00

Add
For Stayfast or Topline
St11 and St14 Only \$ 340.00

Add
For Stayfast or Topline (St) Colors
other than St11 and St14 \$ 410.00



Electron Top

YEAR	CAR IDENTIFICATION	List Price TR01, TR02 CN05 or CN06 US Dollars	Stock Number	Bow Height	Approx Installation Time
CHRYSLER		Imperials Listed Separately on Page 50			
1946-48	Standard or Town & Country Vinyl Curtain Brass Zipper (Color Matched) Double Blank Window Brass Zipper (When Purchased with the Top) Standard Universal Front & Rear Pad Set 75" Black Lining	\$ 525.00 \$ 210.00 \$ 230.00 \$ 128.00	CH 0480	21 1/2"	8 2 3
1949-52	All Models Windsor, Town & Country, New Yorker Vinyl Curtain Brass Zipper (Color Matched) Double Blank Window Brass Zipper (When Purchased with the Top) Standard Universal Front & Rear Pad Set 75" Black Lining	\$ 525.00 \$ 210.00 \$ 230.00 \$ 128.00	CH 1000	23 "	8 2 3
1953-54	All Models Vinyl Curtain Brass Zipper (Color Matched) Standard Universal Front & Rear Pad Set 75" Black Lining	\$ 525.00 \$ 210.00 \$ 128.00	CH 1400	26 "	8 2
1955-55	All Models Vinyl Curtain Brass Zipper (Color Matched) Standard Universal Front & Rear Pad Set 75" Black Lining	\$ 525.00 \$ 210.00 \$ 128.00	CH 1650	23 1/2"	8 2
1956-56	All Models - (Except Imperials) Vinyl Curtain Brass Zipper (Wrap Around Color Matched) Standard Universal Front Pad Set 75" Black Lining Note: If a Narrower Vinyl Window Is Desired (Use CH 1650)	\$ 525.00 \$ 245.00 \$ 76.00	CH 1810	23 1/2"	8 2
1957-59	All Models - (Except Imperials) Vinyl Curtain Brass Zipper (Color Matched) Standard Universal Front & Rear Pad Set 75" Black Lining	\$ 450.00 \$ 210.00 \$ 128.00	CH 2120	26 3/4"	8 2
1960-60	All Models - (Except Imperials) Vinyl Curtain Brass Zipper (No Bottom Strip) Standard Universal Front Pad Set 60" Black Lining	\$ 450.00 \$ 196.00 \$ 68.00	CH 3000	28 1/2?"	7 2
1961-61	All Models - (Except Imperials) Vinyl Curtain Brass Zipper (No Bottom Strip) Standard Universal Front Pad Set 60" Black Lining	\$ 450.00 \$ 196.00 \$ 68.00	CH 3140	28 1/2?"	7 2
1962-62	All Models - (Except Imperials) Vinyl Curtain Brass Zipper (No Bottom Strip) Standard Universal Front Pad Set 66" Black Lining	\$ 450.00 \$ 196.00 \$ 70.00	CH 3210	29 1/4?"	7 2
1963-64	All Models - (Except Imperials) Vinyl Curtain Brass Zipper (No Bottom Strip) Standard Universal Front Pad Set 66" Black Lining	\$ 450.00 \$ 196.00 \$ 70.00	CH 3370	30 1/4"	6 2
1965-66	All Models - (Except Imperials) Vinyl Curtain Brass Zipper (No Bottom Strip) Standard Universal Front Pad Set 60" Well Black Note: Has a 68" Windshield	\$ 375.00 \$ 196.00 \$ 68.00 \$ 300.00	CH 3520	27 3/4"	7 2
1967-68	All Models - (Except Imperials) Vinyl Curtain Brass Zipper (No Bottom Strip) Standard Universal Front Pad Set 66" Glass Window Note: Original Material- Crush Grain	\$ 335.00 \$ 196.00 \$ 70.00 \$ 360.00	CH 3690 ET 2500	29 3/4?"	7 2 3

* Pricing below is for tops only not accessories *

Materials Other than Listed Above or Below, Please Call for Availability and Prices.

Add
for Oe01 or Oe02
Black Lining \$ 44.00

***Add* for Oe or Sa**
Materials Not Listed Above
and/or W/ Tan Lining \$ 100.00

Add
For Stayfast or Topline
St11 and St14 Only \$ 340.00

Add
For Stayfast or Topline (St) Colors
other than St11 and St14 \$ 410.00

YEAR	CAR IDENTIFICATION	List Price TR01, TR02 CN05 or CN06	Stock Number	Bow Height	Approx Installation Time
		US Dollars			
	Chrysler				
1969-70	All Models Vinyl Curtain Brass Zipper (Color Matched) Standard Universal Front Pad Set 66" Glass Window	\$ 345.00 \$ 210.00 \$ 70.00 \$ 360.00	CH 3890 ET 2550	33 1/4"	7 2 3
	Black Lining				
1982-83	LeBaron Vinyl Curtain Plastic Zipper (Color Matched) Spl Front Pad Set Spl Rear Pad Set Well Black Side Cables (See Cable Pages) Suggested Color OE02 TR01 TR02	\$ 324.00 \$ 196.00 \$ 78.00 \$ 44.00 \$ 190.00 \$ 44.00	CH 4820	24 1/2"	6 2
	Black Lining				
	Black Lining (Cn08)				
1984-86	LeBaron Vinyl Curtain Plastic Zipper (Color Matched) Spl Front Pad Set Well Black Side Cables (See Cable Pages) Glass Window Tinted Suggested Color OE02 OE27 TR01 TR02	\$ 324.00 \$ 196.00 \$ 78.00 \$ 190.00 \$ 42.00 \$ 300.00	CH 4860 ET 2570	23 1/4"	6 2 3
	Black Lining (Cn08)				
1987-91	Chrysler Maserati Specify Headliner Color (Tan or Black) Vinyl Curtain (Color Matched) (Glass Window (Customer Supplies Glass - Call for Details)) (Glass Window) Electron Top Supplies Glass Note: We recommend installing brackets using a 2 part urethane. Brackets can be installed with a 2 part epoxy or 3M Adhesive. Please Allow 4-5 Working Days for manufacturing.	\$ 540.00 \$ 875.00 \$ 250.00 \$ 340.00 \$ 460.00	CH 4960 ET 4960 ET 4961		8 2
	St11				
1987-95	LeBaron Vinyl Curtain Plastic Zipper (Color Matched) Spl Webbing Pad Set 4" x 53" (Patch Attached) (See Pad Pages) Side Cables (See Cable Pages) Glass Window Tinted Glass Window Tinted with Defroster Headliner Avail in Agate, Dk Blue, Lt Quartz, Buckskin & Bordeaux 1987-89 Pinpoint Vinyl Made with Wire-on 1990-95 Sailcloth Vinyl Made with Bowleeve (1990 May Have Wire-on Please Specify) Suggested Color Tr01 Tr02 Oe06 Oe11 Oe19 Oe27 Sa13 thru Sa17 Note: See Manufacturers TSB'S on our Website	\$ 324.00 \$ 196.00 \$ 46.00 \$ 52.00 \$ 300.00 \$ 370.00 \$ 445.00	CH 4900 ET 2590t ET 2590h	22 1/2"	6 2 3 3
	Sa13 or Sa14				
1996-06	Sebring (Raingutter Above Doors) Suggested Retail Vinyl Curtain (Color Matched) Packed in Glass Box Side Cables (See Cable Pages) Rear Springs (w/ nylon netting) Pair Glass Window Tinted with Defroster (With Extrusions) Headliner Black Ribbed Foam (Like Original 1996-06) * For any other color headliner call for pricing (Special Order) Spl Webbing Pad Set with Extrusions as Original (See Pad Pages) Original Material 1996-06 Sailcloth & Twillfast Prior to 2006 Change OEM Pads-Rubber Coating Deteriorates Note: See Manufacturers TSB'S on our Website	\$ 324.00 \$ 720.00 \$ 200.00 \$ 66.00 \$ 38.00 \$ 440.00 \$ 500.00 \$ 96.00	CH 4941 ET 2600h	26 1/2"	6 2 3
	Sa13, Sa14, Sa20 or Sa30 St23, St24, St25 or St27				

* Labor times are based on when the cars were new *

Materials Other than Listed Above or Below, Please Call for Availability and Prices.

Add
for Oe01 or Oe02
Black Lining \$ 44.00

***Add* for Oe or Sa**
Materials Not Listed Above
and/or W/ Tan Lining \$ 100.00

Add
For Stayfast or Topline
St11 and St14 Only \$ 340.00

Add
For Stayfast or Topline (St) Colors
other than St11 and St14 \$ 410.00



YEAR	CAR IDENTIFICATION	List Price TR01, TR02 or SA	Stock Number	Bow Height	Approx Installation Time
	Chrysler	US Dollars			
1996-06	Sebring Economy Top (One Piece Top Vinyl Window) Available in These Colors Only Sa13, Sa14, Sa20 or Sa30 Side Cables (See Cable Pages) \$ 66.00 Rear Springs (w/ nylon netting) Pair \$ 38.00 Headliner Black Ribbed Foam (Like Original 1996-06) \$ 500.00 * For any other color headliner call for pricing (Special Order) Spl Webbing Pad Set with Extrusions as Original (See Pad Pages) \$ 96.00 <i>Note: See Manufacturers TSB'S on our Website</i>	\$ 380.00	CH 4945	26 1/2"	6
1997-02	Prowler Roadster St11, St13 or St14 Heated Glass Window is Part of Top Spl Webbing Pads (See Pad Pages) \$ 40.00 <i>Note: Please Allow 4-5 Working Days for Manufacturing</i>	\$ 1000.00	CH 5450	15 1/4"	5
2004-09	Crossfire Roadster Gr11 Heated Glass Window is Part of Top Side Cables (See Cable Pages) \$ 178.00 <i>Note: We Need (4) Extrusions from Old Top.</i> Core Charge: (If We Send Top Before Getting Extrusions) \$ 700.00 Original Material 2004-09 Sonnenland Sg11	\$ 1350.00 \$ 1230.00	CH 5460		6
2007-14	Sebring & 200 (Must Reuse Glass) Sa13 Side Cables (See Cable Pages) \$ 94.00 <i>Note: Needs Mopar Part # 1-04076274AB Black Tape for Window</i> Original Material 2007-10 Sailcloth & Twillfast St24 or St27	\$ 370.00 \$ 780.00 \$ 25.00	CH 5010		6
2004-09	PT Cruiser Cabrio Heated Glass Window is Part of Top <i>Note: Headliner is Padded and has Velcro Around Rear Window</i>	Call			

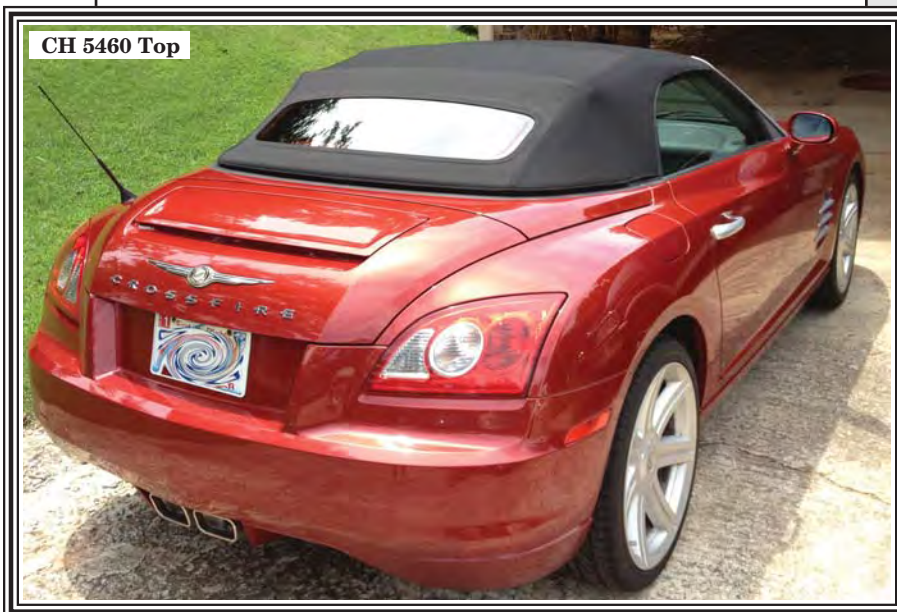

**Compliments of
Kenny
Convertible Top Man, GA.
2006 Crossfire**

* Pricing below is for tops only not accessories *

Materials Other than Listed Above or Below, Please Call for Availability and Prices.

***Add* To Sa13 For
Sa or OE Not Listed Above
and/or W/ Tan Lining \$ 100.00**

***Add*
To St11 for St Colors
Not Listed \$ 100.00**

***Add* To
GR11 or SG11 for GR or SG Colors
Not Listed \$ 100.00**



GM 1880 Top



GM 2250 Top



GM 6571 Top



GM 3720 Top



CH 5450 Top

GM 3940 Top



***"Custom
Quality
Tops!"***



YEAR	CAR IDENTIFICATION	List Price TR01 or TR02	Stock Number	Bow Height	Approx Installation Time
	CONVERSION	US Dollars			
1994-95	Nissan 300ZX (1 Window Conversion)	Request	CV 5300		
1988-??	Archer (Coach Kit Car)	Request	CV 5550		
1987-??	Subaru GT	Request	CV 6480		
1964-67	Volvo Conversion	Request	CV 6690		
1983-??	Jaguar XJS (Coach Builders Ltd., FL Don McCullans)	Request	CV 6950		
1977-??	Emiss Mustang	Request	CV 6960		
1980-??	Toyota (Popano Beach, FL)	Request	CV 7420		
1983-??	Datsun	Request	CV 7430		
1979-85	Eldorado (Hess & Eisenhardt) Vinyl Curtain (Color Matched) Standard Universal Front Pad Set 66" Black Lining Glass Curtain (Glass Must be Supplied by Customer) Glass Curtain (Square Side Ears not Pointed Like 7450)	Request \$ 230.00 \$ 70.00 \$ 400.00 \$ 400.00	CV 7450 ET 7450 ET 7451		
1979-??	Eldorado "St. Maritz" (Global Coach & Armour) Vinyl Curtain (Color Matched) Standard Universal Front Pad Set 66" Black Lining Glass Curtain (Glass Must be Supplied by Customer)	Request \$ 230.00 \$ 70.00 \$ 400.00	CV 7460 ET 7460		
1982-??	Mercedes 300CZ (Converted from a 2 Door)	Request	CV 7470		
1982-??	Cadillac (Hess & Eisenhardt) Glass Curtain (Glass Must be Supplied by Customer)	Request \$ 400.00	CV 7530 ET 7530		
1982	Cadillac Coupe Deville (Car Craft) Glass Curtain (Glass Must be Supplied by Customer)	Request \$ 400.00	CV 7780 ET 7780		
1984-??	Oldsmobile Cutlass Sierra (Hess & Eisenhardt) Vinyl Curtain (Color Matched) Standard Universal Front Pad Set 66" Black Lining Glass Curtain (Glass Must be Supplied by Customer)	Request \$ 230.00 \$ 70.00 \$ 400.00	CV 7600 ET 7600		
1982-??	Olds Cutlass (Hess & Eisenhardt Vinyl Curtain Model)	Request	CV 7620		
1980-??	Cadillac Coupe Deville (Car Craft)	Request			
????	Chrysler Cordova ?	Request	CV 7640		
1988-??	Olds Cutlass Supreme	Request	CV 7770		
1983-??	Toyota Corolla	Request	CV 7920		
1984-??	Toyota Celica	Request	CV 7930		
1981-??	Datsun Conversion (3 Windows)	Request	CV 7940		

* Pricing below is for tops only not accessories *

Materials Other than Listed Above or Below, Please Call for Availability and Prices.

Add
for Oe01 or Oe02
Black Lining \$ 44.00

***Add* for Oe or Sa**
Materials Not Listed Above
and/or W/ Tan Lining \$ 100.00

Add
For Stayfast or Topline
St11 and St14 Only \$ 340.00

Add
For Stayfast or Topline (St) Colors
other than St11 and St14 \$ 410.00

YEAR	CAR IDENTIFICATION	List Price TR01 or TR02	Stock Number	Bow Height	Approx Installation Time
	<div style="border: 1px solid black; padding: 5px; display: inline-block;">CORVETTE</div>	US Dollars			
	<div style="border: 3px double black; padding: 5px; margin-bottom: 10px;"> Special Note on Centerdeck Seams: Vinyl Material is Heatsealed. Cloth Material is Top-Stitched. </div> <p>NOTE: Vinyl Windows are reverse heatsealed like original. NOTE: Warning tag is sewn into binding beneath vinyl window.</p> <p style="text-align: center;">** Date Stamp available from 1953 to 1975</p>	<div style="border: 1px solid black; padding: 5px; margin-bottom: 5px;">WARNING</div> <div style="border: 1px solid black; padding: 5px; margin-bottom: 5px;">DEALER-DO NOT REMOVE</div> <div style="border: 1px solid black; padding: 5px;"> FOR CARE OF REAR WINDOW SEE BOOKLET HOW TO OPERATE FOLDING TOP </div>			
1953-55	Removable Side Curtains Vinyl Window is Sewn in or Sealed into Top 2" Webbing Strips Supplied with Top Side Curtains Not Available	\$ 440.00 included included	GM 1480	15 1/2"	5.5
1956-60	Flat Rear Deck Vinyl Window is Sealed into Top Spl Front Pad Set Spl Rear Webbing Pads	\$ 440.00 included \$ 34.00 included	GM 1880	15 3/4"	5.5
1961-62	Raised Rib Down Center of Rear Deck Vinyl Window is Sealed into Top Spl Front Pad Set Spl Rear Webbing Pads	\$ 440.00 included \$ 34.00 included	GM 3010	15 3/4"	5.5
1963-67	Stingray Vinyl Window is Sealed into Top Spl Front Pad Set (See Pad Pages) Spl Rear Webbing Pads Included with Front Pads	\$ 440.00 included \$ 34.00 included	GM 3330	18 3/4"	5.5
1968-75	Roadster Vinyl Window is Sealed into Top Spl Front Pad Set Spl Rear Webbing Pads Rear Bow Cable (1973-75 Only) Side Cables (See Cable Pages) (Early 1968 12 3/4") Side Cables (See Cable Pages) (Late 1968 to 75 23 1/8") Original Material 1968-75 Pinpoint Vinyl	\$ 440.00 included \$ 34.00 included \$ 32.00 \$ 106.00 \$ 70.00	GM 3780	15 1/2"	5.5
	<div style="border: 1px solid black; padding: 5px;"> GM 3010 Frame  </div>	<div style="border: 1px solid black; padding: 5px; margin-top: 10px;"> Special Note How to measure the bow height on an outside bow on a Corvette. </div>			
	* Labor times are based on when the cars were new *				

Materials Other than Listed Above or Below, Please Call for Availability and Prices.

Add
 For Pinpoint OE Colors
 Black Lining \$ 44.00

Add
 For Pinpoint OE Colors
 Tan Lining \$ 100.00

Add
 For Stayfast or Topline
 ST11 and ST14 Only \$ 310.00

Add
 For Stayfast or Topline ST Colors
 and/or with Tan Lining \$ 410.00



YEAR	CAR IDENTIFICATION	List Price TR01 or TR02	Stock Number	Bow Height	Approx Installation Time
	Corvette	US Dollars			
1986-93	Roadster (Vinyl Binding) Vinyl Window is Sealed into Top and Stitched 9" Webbing Pads (See Pad Pages) Spl Rear Webbing Pads (See Pad Pages) Side Cables (See Cable Pages) Headliner Available in Black Plastic Insert Hard Glass Top Available Call for Details Suggested Color Oe02 St11 St13 St14 Tr01 Tr02 Ts20	\$ 480.00 \$ 710.00 included \$ 30.00 \$ 20.00 \$ 48.00 \$ 345.00 included	GM 3800	17 "	7
1994-96	Roadster (Top/Glass Tinted Only) Tr01 or Tr02 (Top/Glass Tinted with Defroster) Tr01 or Tr02 (Top/Glass Tinted Only) St11 or St14 (Top/Glass Tinted with Defroster) St11 or St14 9" Webbing Pads (See Pad Pages) Spl Rear Webbing Pads (See Pad Pages) Side Cables Available (See Cable Pages) Headliner Available in Black Please Allow 4-5 Working Days for Manufacturing Note: If Vinyl Window is Needed Order GM 3800 Suggested Color St11 St20 Ts20	\$ 660.00 \$ 730.00 \$ 890.00 \$ 960.00 \$ 30.00 \$ 20.00 \$ 48.00 \$ 345.00	GM 3810	17 "	7
		Compliments of Sunrise Auto Uph Lynbrook, NY. 1992 Chevrolet Corvette			
Special Note: GM3810 top with glass can be used on the earlier 1986-93 model. We no longer carry the glass adaptor kit. The customer must manually guide the glass when putting the top down.		Special Note on Centerdeck Seams: Vinyl Material is Heatsealed. Cloth Material is Top-Stitched.			
* Pricing below is for tops only not accessories *					

Materials Other than Listed Above or Below, Please Call for Availability and Prices.

Add
For Pinpoint OE Colors
Black Lining \$ 44.00

Add
For Pinpoint OE Colors
Tan Lining \$ 100.00

Add
To St11 For St Colors
Not Listed \$ 100.00

YEAR	CAR IDENTIFICATION	US Dollars	Stock Number	Bow Height	Approx Installation Time
1998-04	<div style="border: 1px solid black; padding: 5px; display: inline-block;">Corvette</div> Roadster (Top/Glass Tinted with Defroster) Se28 \$ 700.00 (Top/Glass Tinted with Defroster) St11 \$ 950.00 (Top/Glass Tinted with Defroster) Sg11 or Sg26 \$ 1010.00 9" Webbing Pads (See Pad Pages) \$ 30.00 Side Cables (See Cable Pages) \$ 82.00 Headliner Available in Black \$ 345.00 1998-2000 has a half moon shape cut out in quarters to accommodate rear bow connectors. Late 2000-04 has a flush edge no cut outs. Note: Please Allow 4-5 Working Days for Manufacturing Suggested Color SG11 SG26 SE28 Original Material Sailcloth Vinyl & Twillfast		GM 3880		7
	Roadster (Top/Glass Tinted with Defroster) Se28 \$ 700.00 (Top/Glass Tinted with Defroster) St11 \$ 950.00 (Top/Glass Tinted with Defroster) Sg11 \$ 1050.00 Headliner Available in Charcoal Rib \$ 700.00 Headliner Available in Black Rib \$ 394.00 Side Cables (See Cable Pages) \$ Call Note: Please Allow 4-5 Working Days for Manufacturing Suggested Color SG11 SE28 Original Material 2005 Sailcloth Vinyl & Twillfast 2006-10 Twillfast		GM 3940	19 1/4"	7



GM 3940 Top

Electron Top
2005 Corvette

* Labor times are based on when the cars were new *

Materials Other than Listed Above or Below, Please Call for Availability and Prices.

<p>*Add* To SE28 For SE Colors Black Lining \$ 44.00</p>	<p>*Add* To SE28 For OE Colors Tan Lining \$ 100.00</p>	<p>*Add* To ST11 For ST Colors Not Listed \$ 100.00</p>	<p>*Add* To SG11 For SG Colors Not Listed \$ 100.00</p>
---	--	--	--



YEAR	CAR IDENTIFICATION	List Price TR01 or TR02	Stock Number	Bow Height	Approx Installation Time
		US Dollars			
	DESOTO				
1942-48	All Models Vinyl Curtain Brass Zipper (Color Matched) Double Blank Window Brass Zipper (When Purchased with the Top) Standard Universal Front & Rear Pad Set 75" Black Lining	\$ 525.00 \$ 210.00 \$ 230.00 \$ 128.00	CH 0480	21 1/2"	8 2 3
1949-52	All Models Vinyl Curtain Brass Zipper (Color Matched) Double Blank Window Brass Zipper (When Purchased with the Top) Standard Universal Front & Rear Pad Set 75" Black Lining	\$ 525.00 \$ 210.00 \$ 230.00 \$ 128.00	CH 1000	23 "	8 2 3
1953-54	All Models Vinyl Curtain Brass Zipper (Color Matched) Standard Universal Front & Rear Pad Set 75" Black Lining	\$ 525.00 \$ 210.00 \$ 128.00	CH 1400	26 "	8 2
1955-55	All Models Vinyl Curtain Brass Zipper (Color Matched) Standard Universal Front & Rear Pad Set 75" Black Lining	\$ 525.00 \$ 210.00 \$ 128.00	CH 1650	23 1/2"	8 2
1956-56	All Models Vinyl Curtain (Wrap Around Color Matched) Standard Universal Front Pad Set 75" Black Lining Note: If a Narrower Vinyl Window is Desired Use CH 1650	\$ 525.00 \$ 245.00 \$ 76.00	CH 1810	23 1/2"	8 2
1957-59	All Models Vinyl Curtain Brass Zipper (Color Matched) Standard Universal Front & Rear Pad Set 75" Black Lining	\$ 450.00 \$ 210.00 \$ 128.00	CH 2120	26 3/4"	8 2



CH 1810 Top

**Compliments of
 Mr Edwin A. O'Leary
 1956 Desoto Pace Car**

* Pricing below is for tops only not accessories *

Materials Other than Listed Above or Below, Please Call for Availability and Prices.

Add
 for Oe01 or Oe02
 Black Lining \$ 44.00

***Add* for Oe or Sa**
Materials Not Listed Above
 and/or W/Tan Lining \$ 100.00

Add
 For Stayfast or Topline
 St11 and St14 Only \$ 340.00

Add
 For Stayfast or Topline (St) Colors
 other than St11 and St14 \$ 410.00

"Our Reputation is Tops!"

YEAR	CAR IDENTIFICATION	List Price TR01, TR02, CN05 or CN06	Stock Number	Bow Height	Approx Installation Time
	DODGE	US Dollars			
1946-48	All Models Vinyl Curtain Brass Zipper (Color Matched) Double Blank Window Brass Zipper (When Purchased with the Top) Standard Universal Front & Rear Pad Set 75" Black Lining	\$ 525.00 \$ 210.00 \$ 230.00 \$ 128.00	CH 0480	21 1/2"	8 2 3
1949-52	All Models (Except Wayfarer) Vinyl Curtain Brass Zipper (Color Matched) Double Blank Window Brass Zipper (When Purchased with the Top) Standard Universal Front & Rear Pad Set 75" Black Lining	\$ 525.00 \$ 210.00 \$ 230.00 \$ 128.00	CH 1000	23 ?	8 2 3
1953-54	All Models Vinyl Curtain Brass Zipper (Color Matched) Standard Universal Front & Rear Pad Set 75" Black Lining	\$ 525.00 \$ 210.00 \$ 128.00	CH 1410	23 1/2"	8 2
1955-56	All Models (Bound Across Front Bow) Vinyl Curtain Brass Zipper (Color Matched) Standard Universal Front & Rear Pad Set 75" Black Lining	\$ 525.00 \$ 210.00 \$ 128.00	CH 1640	24 1/2"	8 2
1957-58	All Models Vinyl Curtain Horseshoe Brass Zipper (Color Matched) Standard Universal Front Pad Set 66" Black Lining	\$ 475.00 \$ 210.00 \$ 70.00	CH 2130	24 "	8 2
1959-59	All Models Vinyl Curtain Brass Straight Zipper (Color Matched) Standard Universal Front Pad Set 66" Black Lining	\$ 475.00 \$ 210.00 \$ 70.00	CH 2660	24 1/2?	8 2
1960-61	All Models Vinyl Curtain Brass Zipper (No Bottom Strip) Standard Universal Front Pad Set 66" Black Lining	\$ 450.00 \$ 196.00 \$ 70.00	CH 3020	24 1/2"	8 2
1962-62	B Body - Dart, Polara SD2 Vinyl Curtain Brass Zipper (No Bottom Strip) Standard Universal Front Pad Set 60" Black Lining	\$ 450.00 \$ 196.00 \$ 68.00	CH 3170	29 1/2"	7 2
1963-63	B Body - Polara 500 Vinyl Curtain Brass Zipper (No Bottom Strip) Standard Universal Front Pad Set 60" Black Lining	\$ 450.00 \$ 196.00 \$ 68.00	CH 3350	27 "	7 2
1962-65	C Body - Custom 880 Vinyl Curtain Brass Zipper (No Bottom Strip) Standard Universal Front Pad Set 66" Black Lining	\$ 450.00 \$ 196.00 \$ 70.00	CH 3210	29 1/4?	7 2
1963-65?	A Body - Dart GT (Check Bow Height 26 ") Vinyl Curtain Brass Zipper (No Bottom Strip) Spl Front Pad Set Well Black Black Lining (Cn08)	\$ 360.00 \$ 196.00 \$ 79.00 \$ 250.00	CH 3400	26 ?	7 2
1964-65	B Body - Polara 500, Coronet 440, 500 Vinyl Curtain Brass Zipper (No Bottom Strip) Standard Universal Front Pad Set 60" Black Lining Note: Has a 62" Windshield	\$ 375.00 \$ 196.00 \$ 68.00	CH 3570	27 "	7 2

* Labor times are based on when the cars were new *

Materials Other than Listed Above or Below, Please Call for Availability and Prices.

Add
for Oe01 or Oe02
Black Lining \$ 44.00

***Add* for Oe or Sa**
Materials Not Listed Above
and/or W/ Tan Lining \$ 100.00

Add
For Stayfast or Topline
St11 and St14 Only \$ 340.00

Add
For Stayfast or Topline (St) Colors
other than St11 and St14 \$ 410.00

DESOTO
DODGE



YEAR	CAR IDENTIFICATION	List Price TR01, TR02 CN05 or CN06	Stock Number	Bow Height	Approx Installation Time
	Dodge	US Dollars			
1965-66	C Body - Polara 500, Custom, Monaco Vinyl Curtain Brass Zipper (No Bottom Strip) Standard Universal Front Pad Set 60" Well Black Note: Has a 68" Windshield	\$ 375.00 \$ 196.00 \$ 68.00 \$ 300.00	CH 3520	27 3/4"	7 2
		Black Lining (Cn08)			
1965-66	A Body - Dart 270 GT (Check Bow Height 24.5") Vinyl Curtain Brass Zipper (No Bottom Strip) Standard Universal Front Pad Set 60" Note: Velcro Between Curtain and Top	\$ 360.00 \$ 196.00 \$ 68.00	CH 3600	24 1/2"	7 2
		Black Lining			
1966-66	B Body - Coronet 440, 500 Vinyl Curtain Brass Zipper (No Bottom Strip) Standard Front Pad Set 60"	\$ 360.00 \$ 196.00 \$ 68.00	CH 4020	25 ?	7 2
		Black Lining			
1967-68	C Body - Polara, Monaco Vinyl Curtain Brass Zipper (No Bottom Strip) Standard Universal Front Pad Set 66" Glass Window Brass Zipper Note: Original Material - Crush Grain	\$ 335.00 \$ 196.00 \$ 70.00 \$ 360.00	CH 3690	29 3/4"	7 2 3
		Black Lining	ET 2500		
1967-69	A Body - Dart Vinyl Curtain Brass Zipper (No Bottom Strip) Standard Universal Front Pad Set 60" Glass Window Brass Zipper (Not Original Size Glass) Uses Same Size Glass as an ET 5020 Note: Original Material - Crush Grain	\$ 335.00 \$ 196.00 \$ 68.00 \$ 360.00	CH 4050	24 3/4"	7 2 3
		Black Lining	ET 2520		
1967-70	B Body - Coronet Vinyl Curtain Brass Zipper (Color Matched) Spl Front Pad Set Glass Window Brass Zipper Note: Original Material - Crush Grain	\$ 335.00 \$ 210.00 \$ 78.00 \$ 360.00	CH 4170	23 1/2"	7 2 3
		Black Lining	ET 2290		
1969-70	C Body - Polara Vinyl Curtain Brass Zipper (Color Matched) Standard Universal Front Pad Set 66" Glass Window Brass Zipper Note: Original Material - Crush Grain	\$ 345.00 \$ 210.00 \$ 70.00 \$ 360.00	CH 3890	33 1/4"	7 2 3
		Black Lining	ET 2550		
1970-71	Challenger Vinyl Curtain Brass Zipper (No Bottom Strip) Standard Universal Front Pad Set 60" Side Cables Well Black Glass Window Brass Zipper Note: Original Material - Crush Grain	\$ 335.00 \$ 182.00 \$ 68.00 \$ 100.00 \$ 250.00 \$ 360.00	CH 4190	22 1/2"	7 2 3
		Black Lining (Cn08)	ET 2560		
1982-83	400 Vinyl Curtain Brass Zipper (Color Matched) Spl Front Pad Set Spl Rear Pad Set Well Black Side Cables (See Cable Pages) Suggested Color OE02 TR01 TR02	\$ 324.00 \$ 196.00 \$ 78.00 \$ 44.00 \$ 190.00 \$ 44.00	CH 4820	24 1/2"	6 2
		Black Lining (Cn08)			

* Pricing below is for tops only not accessories *

Materials Other than Listed Above or Below, Please Call for Availability and Prices.

Add
for Oe01 or Oe02
Black Lining \$ 44.00

***Add* for Oe or Sa**
Materials Not Listed Above
and/or W/ Tan Lining \$ 100.00

Add
For Stayfast or Topline
St11 and St14 Only \$ 340.00

Add
For Stayfast or Topline (St) Colors
other than St11 and St14 \$ 410.00

"Our Reputation is Tops!"

YEAR	CAR IDENTIFICATION	List Price TR01 or TR02	Stock Number	Bow Height	Approx Installation Time
	Dodge	US Dollars			
1984-86	600 - 600 ES Vinyl Curtain Brass Zipper (Color Matched) Spl Front Pad Set Well Black Side Cables (See Cable Pages) Glass Window Tinted Suggested Color OE02 OE27 TR01 TR02	\$ 324.00 \$ 196.00 \$ 78.00 \$ 190.00 \$ 42.00 \$ 300.00	CH 4860 ET 2570	23 1/4"	6 2 3
	Black Lining (Cn08)				
1989-90	Dodge Dakota Note: Rear Window Sewn In, Cement on Rear Bar Suggested Color TR01 SE27	\$ 400.00	CH 4990		7
1990-93	Shadow Vinyl Curtain With Plastic Stiffener (Color Matched) Standard Front Pad Set 55" Webbing Cables	Sa13 \$ 360.00 Se27 or Se28 \$ 400.00 \$ 210.00 \$ 32.00 \$ 48.00	CH 4920	19 "	8 4
1992-94	Viper Targa Roof (Bound Front Edge) Note: Side Curtains Are Not Available	St11 \$ 700.00	CH 4850		3
1995-??	Viper Targa Roof (Folded Front)	St11 \$ 700.00	CH 5110		3
1997-02	Viper Targa Roof (One Piece)	St11 \$ 700.00	CH 5120		3
2003-09	Viper Full Roof (One Piece) Stayfast or Topline Note: Must Reuse Rear Glass ** Original Material on Dodge Vipers ** 1994-2009 Twillfast	Call			



**CH 4860
1984 Dodge 600**

* Labor times are based on when the cars were new *

Materials Other than Listed Above or Below, Please Call for Availability and Prices.

Add
for Oe01 or Oe02
Black Lining \$ 44.00

***Add* for Oe or Sa**
Materials Not Listed Above
and/or W/ Tan Lining \$ 100.00

Add
For Stayfast or Topline
St11 and St14 Only \$ 340.00

Add
For Stayfast or Topline (St) Colors
other than St11 and St14 \$ 410.00



Electron Top

YEAR	CAR IDENTIFICATION	List Price TR01, TR02 or TR03	Stock Number	Bow Height	Approx Installation Time
	EDSEL	US Dollars			
1958-59	Pacer Vinyl Curtain Brass Zipper (Color Matched) Standard Universal Front & Rear Pad Set 75" Black Lining	\$ 525.00 \$ 210.00 \$ 128.00	FO 2050	21 1/2"	8 2
1958-58	Citation Vinyl Curtain Brass Zipper (Color Matched) (Wrap Around Vinyl) Standard Universal Front Pad Set 75" Black Lining Well Black (Cn08)	\$ 525.00 \$ 245.00 \$ 76.00 \$ 220.00	FO 2060	18 "	8 3
1959-59	Corsair Vinyl Curtain Brass Zipper (Color Matched) (Wrap Around Vinyl) Standard Universal Front Pad Set 75" Black Lining	\$ 525.00 \$ 245.00 \$ 76.00	FO 2630	24 3/4"	8 3
1960-60	Ranger Vinyl Curtain Brass Zipper (No Bottom Strip) Standard Universal Front & Rear Pad Set 66" Black Lining	\$ 525.00 \$ 196.00 \$ 122.00	FO 2910	27 1/2"	8 2
					
	FORD	Thunderbirds on Page 70			
1939-39	4 Door Convertible Double Blank Window Brass Zipper (When Purchased with the Top) Standard Universal Front & Rear Pad Set 85" Black Lining	\$ 525.00 \$ 230.00 \$ 134.00	FO 0030		8 3
1946-48	All Model Vinyl Curtain Brass Zipper (Color Matched) Double Blank Window Brass Zipper (When Purchased with the Top) Standard Universal Front & Rear Pad Set 66" Black Lining	\$ 525.00 \$ 210.00 \$ 230.00 \$ 122.00	FO 0450	20 1/2"	8 2 3

* Pricing below is for tops only not accessories *

Materials Other than Listed Above or Below, Please Call for Availability and Prices.

Add
for Oe01 or Oe02
Black Lining \$ 44.00

***Add* for Oe or Sa**
Materials Not Listed Above
and/or W/ Tan Lining \$ 100.00

Add
For Stayfast or Topline
St11 and St14 Only \$ 340.00

Add
For Stayfast or Topline (St) Colors
other than St11 and St14 \$ 410.00

"Our Reputation is Tops!"

YEAR	CAR IDENTIFICATION	List Price TR01, TR02 or TR03	Stock Number	Bow Height	Approx Installation Time
	FORD	US Dollars			
	Thunderbirds on Page 70				
1949-51	All Models Vinyl Curtain Brass Zipper (Color Matched) Double Blank Window Brass Zipper (When Purchased with the Top) Standard Universal Front & Rear Pad Set 66" Black Lining	\$ 525.00 \$ 210.00 \$ 230.00 \$ 122.00	FO 1020	22 1/2"	8 2 3
1952-54	All Models Vinyl Curtain Brass Zipper (Color Matched) Standard Universal Front & Rear Pad Set 75" Black Lining	\$ 525.00 \$ 210.00 \$ 128.00	FO 1720	22 1/2"	8 2
1955-56	All Models (Except Thunderbirds) Vinyl Curtain Brass Zipper (Color Matched) Special Front Pad Set Black Lining Special Rear 1/4 Pads Black Lining Note: Rear tack bar has 2 1/2" bolts that get screwed in about 1/2", bar hangs out on end of the bolts	\$ 450.00 \$ 196.00 \$ 78.00 \$ 52.00	FO 1580	19 1/4"	8 2
1957-58	All Models (Except Thunderbirds) Vinyl Curtain Brass Zipper (Color Matched) Standard Universal Front & Rear Pad Set 75" Black Lining	\$ 525.00 \$ 210.00 \$ 128.00	FO 2050	21 1/2"	8 2
1959-59	All Models (Except Thunderbirds) Wrap Around Vinyl Window Brass Zipper (Color Matched) Standard Universal Front Pad Set 75" Black Lining	\$ 525.00 \$ 245.00 \$ 76.00	FO 2630	24 3/4"	8 3
1960-60	All Models (Except Thunderbirds) Vinyl Curtain Brass Zipper (No Bottom Strip) Standard Universal Front & Rear Pad Set 66" Black Lining Note: Has a 54" Window	\$ 525.00 \$ 196.00 \$ 122.00	FO 2910	27 1/2"	8 2
1960-60	All Models (Except Thunderbirds) Vinyl Curtain Brass Zipper (No Bottom Strip) Standard Universal Front & Rear Pad Set 66" Black Lining Note: Has a 50" Window	\$ 525.00 \$ 196.00 \$ 122.00	FO 3030	27 1/2"	8 2
1961-62	All Models (Except Thunderbirds) Vinyl Curtain Brass Zipper (No Bottom Strip) Standard Universal Front Pad Set 66" Black Lining Well Black (Cn08)	\$ 425.00 \$ 196.00 \$ 70.00 \$ 195.00	FO 3100	27 "	6 2
1963-63	All Models (Except Thunderbirds & Falcon) Vinyl Curtain Brass Zipper (No Bottom Strip) Standard Universal Front Pad Set 66" Black Lining Well Black (Cn08) Note: Well Doesn't Have Drain Tube	\$ 380.00 \$ 182.00 \$ 70.00 \$ 195.00	FO 3290	23 1/4 "	6 2
1963-65	Falcon Vinyl Curtain Brass Zipper (No Bottom Strip) Standard Universal Front Pad Set 60" Black Lining Special Rear 1/4 Pads Black Lining Well Black (Cn08)	\$ 380.00 \$ 182.00 \$ 68.00 \$ 52.00 \$ 195.00	FO 3280	23 1/2"	6 2

* Labor times are based on when the cars were new *

Materials Other than Listed Above or Below, Please Call for Availability and Prices.

Add
for Oe01 or Oe02
Black Lining \$ 44.00

***Add* for Oe or Sa**
Materials Not Listed Above
and/or W/ Tan Lining \$ 100.00

Add
For Stayfast or Topline
St11 and St14 Only \$ 340.00

Add
For Stayfast or Topline (St) Colors
other than St11 and St14 \$ 410.00

EDSEL
FORD

"Our Reputation is Tops!"

YEAR	CAR IDENTIFICATION	List Price TR01, TR02 or TR03	Stock Number	Bow Height	Approx Installation Time
	Ford	US Dollars			
	Thunderbirds on Page 70				
1969-72	Galaxie 500, Galaxie XL, LTD	\$ 324.00	FO 4120	30 "	6
	Vinyl Curtain Brass Zipper (Color Matched)	\$ 196.00			
	Glass Window Brass Zipper Tinted	\$ 340.00	ET 2130		
	Spl Front Pad Set 66"	\$ 78.00			
	Spl Rear Pad Set	\$ 52.00			
	Side Cables Galaxie Only (See Cable Pages)	\$ 54.00			
	Well Black (Cn08)	\$ 195.00			
1969-70	Mustang	\$ 324.00	FO 4130	20 1/2"	6
	Vinyl Curtain Brass Zipper (No Bottom Strip)	\$ 182.00			
	Glass Window is Hinged Brass Zipper Clear Only	\$ 386.00	ET 2110		
	Front Webbing Pad Set (See Pad Pages)	\$ 76.00			
	Spl Rear Webbing Pad Set (See Pad Pages)	\$ 58.00			
	Well Black (Cn08)	\$ 195.00			
	Side Cables (See Cable Pages)	\$ 54.00			
1971-73	Mustang	\$ 324.00	FO 4140	24 1/2"	6
	Vinyl Curtain Brass Zipper (Color Matched)	\$ 196.00			
	Spl Front Webbing Pad Set 50" (See Pad Pages)	\$ 120.00			
	Spl Rear Webbing Pad Set (See Pad Pages)	\$ 58.00			
	Spl Front Pad Set	\$ 68.00			
	Spl Rear Pad Set	\$ 36.00			
	Well Black (Cn08)	\$ 195.00			
	Glass Window Brass Zipper	\$ 310.00	ET 2140		
	Side Cables (See Cable Pages)	\$ 44.00			

FORD

Mustangs
using
this top #
Might be
19"



Fo 3510 Top

**Compliments of
Kenny McCombs
Convertible Top Man, GA.
1965 Mustang**

* Labor times are based on when the cars were new *

Materials Other than Listed Above or Below, Please Call for Availability and Prices.

Add
for Oe01 or Oe02
Black Lining \$ 44.00

***Add* for Oe or Sa**
Materials Not Listed Above
and/or W/ Tan Lining \$ 100.00

Add
For Stayfast or Topline
St11 and St14 Only \$ 340.00

Add
For Stayfast or Topline (St) Colors
other than St11 and St14 \$ 410.00

YEAR	CAR IDENTIFICATION	List Price TR01, TR02	Stock Number	Bow Height	Approx Installation Time
	Ford	US Dollars			
1994-00	Mustang & Cobra Oe14, Oe22, Sa13, Sa23, Sa24 & Sa26 Suggested Retail Se27 Vinyl Curtain (Color Matched) Webbing Pad Set 6" x 55" (See Pad Pages) Side Cables (See Cable Pages) Rear 1/4 Cables (Fits 94-04 Only) (See Cable Pages) Well Black With Extrusion (Cn08) Glass Window Tinted Glass Window Tinted & Defrosted Headliner Available Black (94-98) Headliner Available Charcoal (99-04) Headliner Available Charcoal (99-04) Foam Backed Note: Need measurements on cables when ordering Original Material 1994-95 Pinpoint Vinyl 1995-00 Sailcloth Vinyl	\$ 324.00 \$ 360.00 \$ 196.00 \$ 28.00 \$ 58.00 \$ 96.00 \$ 180.00 \$ 330.00 \$ 410.00 \$ 368.00 \$ 386.00 \$ 476.00	FO 4280	24 1/2"	7 ET 2180t ET 2180h 3 3 1 1 1
2001-04	Mustang & Cobra Sa13, Sa24, Sa26 & Sa31 Suggested Retail Se27 (Rubber Extrusion Above Door Window) Vinyl Curtain (Color Matched) Webbing Pad Set 6" x 55" (See Pad Pages) Side Cables (See Cable Pages) Rear 1/4 Cables (Fits 94-04) (See Cable Pages) Well Black With Extrusion (Cn08) Glass Window Tinted Glass Window Tinted & Defrosted Headliner Available Charcoal (99-04) Headliner Available Charcoal (99-04) Foam Backed Original Material 2001-04 Sailcloth	\$ 334.00 \$ 370.00 \$ 196.00 \$ 28.00 \$ 58.00 \$ 96.00 \$ 180.00 \$ 330.00 \$ 410.00 \$ 386.00 \$ 476.00	FO 4290	24 1/2"	7 ET 2180t ET 2180h 3 3 1 1
1994-04	Mustang & Cobra (Economy Top) Sa13, Sa23, Sa24 & Sa26 (One piece top with vinyl window built in) Webbing Pad Set 6" x 55" (See Pad Pages) Side Cables (See Cable Pages) Rear 1/4 Cables (Fits 94-04 Only) (See Cable Pages) Well Black With Extrusion (Cn08) Headliner Available Black (94-98) Headliner Available Charcoal (99-04) Headliner Available Charcoal (99-04) Foam Backed Note: See Manufacturers TSB'S on our Website	\$ 380.00 \$ 28.00 \$ 58.00 \$ 96.00 \$ 180.00 \$ 368.00 \$ 386.00 \$ 476.00	FO 4260	24 1/2"	6 1 1 1

FORD



**Compliments of
Kenny McCombs
Convertible Top Man, GA.
1998 Mustang**

* Labor times are based on when the cars were new *

Materials Other than Listed Above or Below, Please Call for Availability and Prices.

Add To SA or SE Colors Not Listed Black Lining \$ 44.00	*Add* To Sa13 For OE Colors Not Listed Above and or W/Tan Lining \$ 100.00	*Add* For Stayfast or Topline St11 and St14 Only \$ 340.00	*Add* For Stayfast or Topline (St) Colors other than St11 and St14 \$ 410.00
---	--	--	--

"Our Reputation is Tops!"

YEAR	CAR IDENTIFICATION	Stock Number	Bow Height	Approx Installation Time	
	Ford	US Dollars			
1984-88	Mclaren ASC (Three Windows) See Diagram 1 1/4" Stitch Below Rear Window Please Supply Center Deck Width Note: We Need all Three Measurements Measure Just in Front of Rear Bow Measure Distance Between Bows Velcro on Bows Suggested Color St11 Tr01	St11 or St14	\$ 650.00	FO4210	6
1984-88	Mclaren ASC (Three Windows) See Diagram 7/8" Stitch Below Rear Window Supply Center Deck Width Note: We Need all Three Measurements Measure Just in Front of Rear Bow Measure Distance Between Bows Velcro on Bows Suggested Color St11 Tr01	St11 or St14	\$ 650.00	FO 4220	6
1989-90	Mclaren ASC (Three Windows) See Diagram Suggested Color St11 Tr01	St11 or St14	\$ 650.00	FO 4240	6

**FORD
MCLAREN**

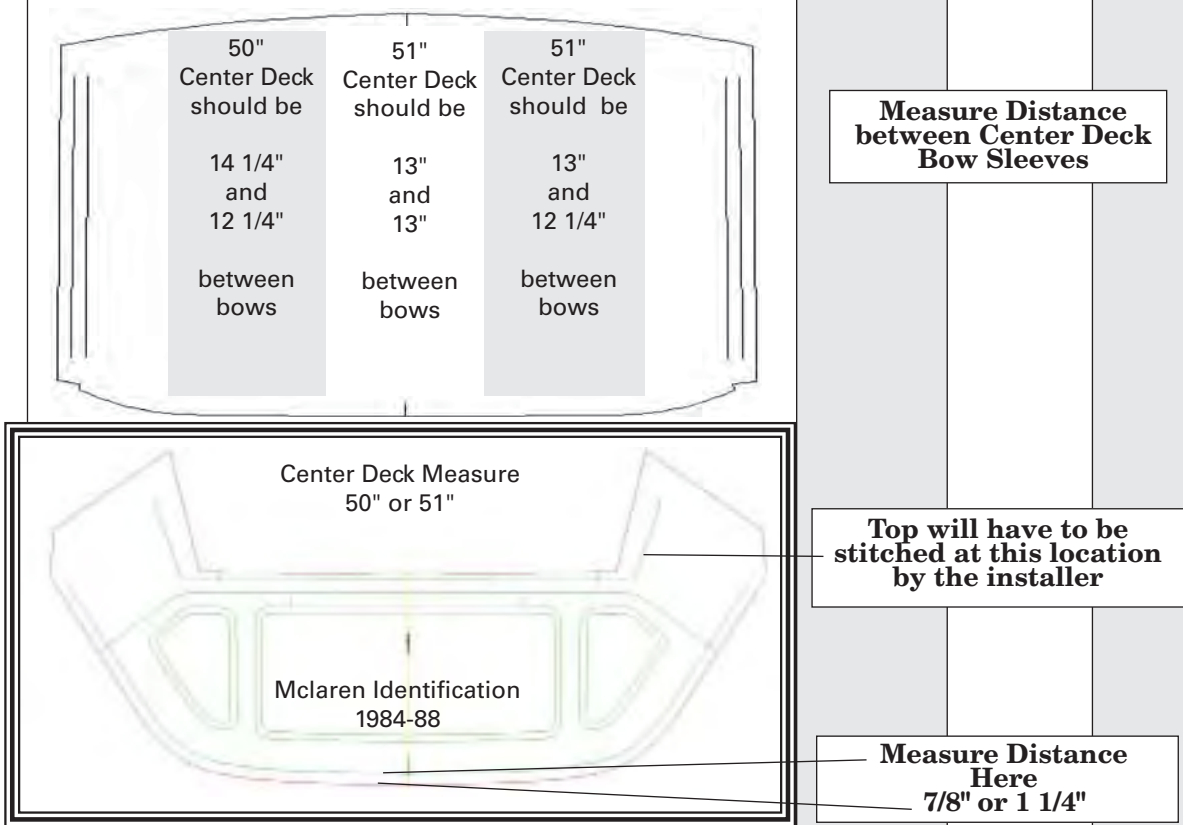

* Labor times are based on when the cars were new *

Materials Other than Listed Above or Below, Please Call for Availability and Prices.

Add
For St Colors Not Listed
Above \$ 70.00



YEAR	CAR IDENTIFICATION	List Price TR01 or TR02	Stock Number	Bow Height	Approx Installation Time
		US Dollars			
	IMPERIAL				
1957-57	Crown Vinyl Curtain Brass Zipper (Wrap Around Color Matched) Standard Universal Front Pad Set 66" Black Lining 1957 & 1958 Crown Imperial while very similar in appearance, they have different size tops. The late 1957 production uses a 1958 top. The rear curtain on the 1958 top fastens to the outside of the body and is covered with a belt molding as most Chrysler products do. The 1957 curtain fastens down inside the body and is clamped between the outside and inside belt molding. The 1958 top will overhang the door windows by about 1 1/2" on each side when installed on an early 1957 model.	\$ 525.00 \$ 245.00 \$ 70.00	CH 2190	28 1/2"	8 2
1958-59	Crown Vinyl Curtain Brass Zipper (Wrap Around Color Matched) Standard Universal Front Pad Set 66" Black Lining	\$ 525.00 \$ 245.00 \$ 70.00	CH 2340	23 1/2"	8 3
1960-61	Crown Vinyl Curtain Brass Zipper (Wrap Around Color Matched) Standard Universal Front Pad Set 66" Black Lining	\$ 525.00 \$ 245.00 \$ 70.00	CH 3050	24 1/2"	8 3
1962-63	Crown Vinyl Curtain Brass Zipper (Wrap Around Color Matched) Standard Universal Front Set 75" Black Lining	\$ 475.00 \$ 245.00 \$ 76.00	CH 3230	29 1/2 "	8 2
1964-66	Crown "D" Body Vinyl Curtain Brass Zipper (Color Matched) Standard Universal Front Pad Set 66" Black Lining	\$ 475.00 \$ 210.00 \$ 70.00	CH 3490	25 3/4"	8 2
1967-68	Crown "C" Body Vinyl Curtain Brass Zipper (Color Matched) Standard Universal Front Pad Set 66" Black Lining Glass Window Available (Not Original Size Glass) Call for Details	\$ 475.00 \$ 210.00 \$ 70.00 \$ 360.00	CH 3700 ET 2530	25 1/2"	8 2 3
	JEEPSTER				
			Also See Sport Utility Page 68		
1948-51	All Models Vinyl Curtain Brass Zipper (Color Matched) Double Blank Window Brass Zipper (When Purchased with the Top) Standard Universal Front & Rear Pad Set 75" Black Lining	\$ 525.00 \$ 210.00 \$ 245.00 \$ 128.00	JE 1220		8 2 3
1966-73	C101 - Commando Convertible Vinyl Curtain Brass Zipper (Color Matched) Standard Universal Front Pad Set 66" Black Lining Note: Must Have A Working Tail Gate	\$ 400.00 \$ 210.00 \$ 70.00	JE 3760		8 2
1966-73	Jeepster Convertible with Continental Kit Vinyl Curtain Brass Zipper (Color Matched) Standard Universal Front Pad Set 66" Black Lining Glass Window Available if Supplied by Customer Note: No Tail Gate, Has a Plastic Cover That Goes Over the Rear Edge of the Top and Vinyl Curtain.	\$ 400.00 \$ 210.00 \$ 70.00 \$ 360.00	JE 3910 ET 3910		8 2 3
2012-13	4 Door Jeep (Omix Powered Top Frame) St11 Vinyl Curtain with Plastic Zipper (Color Matched)	\$ 1200.00 \$ 300.00	JE 3920		3 1

* Pricing below is for tops only not accessories *

Materials Other than Listed Above or Below, Please Call for Availability and Prices.

Add
for Oe01 or Oe02
Black Lining \$ 44.00*Add* for Oe or Sa
Materials Not Listed Above
and/or W/ Tan Lining \$ 100.00*Add*
For Stayfast or Topline
St11 and St14 Only \$ 340.00*Add*
For Stayfast or Topline (St) Colors
other than St11 and St14 \$ 410.00

YEAR	CAR IDENTIFICATION	Stock Number	Bow Height	Approx Installation Time
		US Dollars		
<h2>CLASSIC LINCOLN CONTINENTAL</h2> <h3>1941-48 Continental</h3>				
1941-48	Classic Lincoln Continental (Hardware Kit Included) Made in these Materials Only St01, St04, St11 or St14 Hardware Kit Contains the following: Strap, Buckles, Footman Loops, Hooks, and Aluminum Plates. Glass and Frame (8" x 23") (Sold Separately) Chrome Outside, Tan Inside	\$ 1640.00 Included Call	FO 3163	

NOTE: Our 1941-48 Classic Continental Top is designed detail for detail from an original top. We make it using Haartz Stayfast or Topline; in Blk on Blk, Tan on Tan, or Blk on Tan only. The center deck is one piece from the rear deck to the binding across the front bow. An aluminum plate, supplied with the hardware kit, is screwed to the rear bow between the double material above the rear curtain opening to hold the center deck in position without visible tacks or wireon trim. On the rear bow the original rear curtain is hung on two webbing straps; also supplied with our hardware kit. In addition, we supply the original style rear curtain with our **CLASSIC TOP** and bind the top with top material to duplicate the original.

We also make a production Continental Top that uses a one piece horseshoe zipper on the rear curtain. Sealed vinyl tops are not usually recommended for this type of installation, unless you split the top at the rear bow and install wireon trim over the tack line.

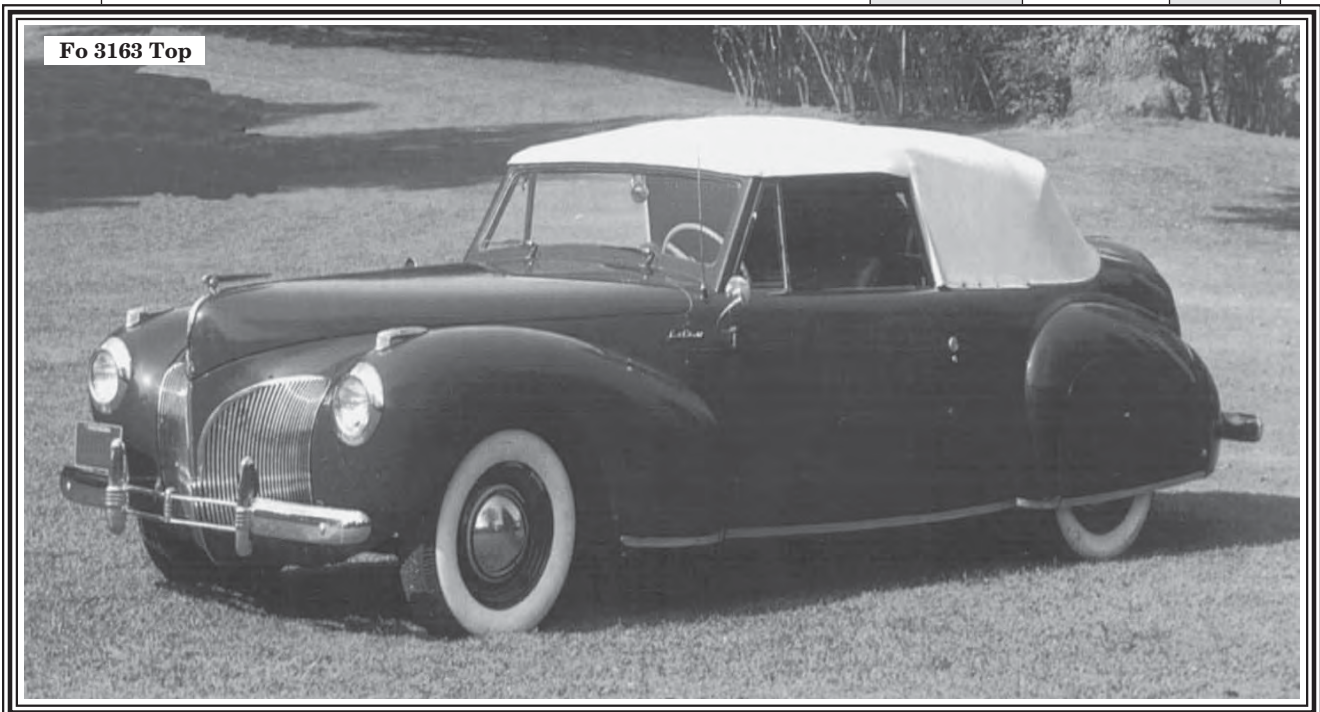

* Labor times are based on when the cars were new *

For Colors and Materials Other than Listed Above, Call for Availability and Price.



Electron Top

YEAR	CAR IDENTIFICATION	List Price TR01, TR02 or TR03	Stock Number	Bow Height	Approx Installation Time
	Lincoln	US Dollars			
1941-48	Continental Vinyl Curtain Brass Zipper (Color Matched) Double Blank Window Brass Zipper (When Purchased with the Top) Standard Universal Front & Rear Pad Set 75" Black Lining	\$ 625.00 \$ 210.00 \$ 230.00 \$ 128.00	FO 3160		2
1949-49	All Models (Except Cosmopolitan) Vinyl Curtain Brass Zipper (Color Matched) Double Blank Window Brass Zipper (When Purchased with the Top) Standard Universal Front & Rear Pad Set 75" Black Lining	\$ 525.00 \$ 210.00 \$ 230.00 \$ 128.00	FO 0770	21 1/2"	8 2 3
1952-55	Capri Vinyl Curtain Brass Zipper (Color Matched) Standard Universal Front & Rear Pad Set 75" Black Lining	\$ 525.00 \$ 210.00 \$ 128.00	FO 1430	24 1/2"	8 2
1956-57	All Models Vinyl Curtain Brass Zipper (Color Matched) Spl Front Pad Set Rear Pad Set 30" Black Lining Black Lining	\$ 525.00 \$ 210.00 \$ 78.00 \$ 52.00	FO 2070	24 "	7 2
1958-60	Continental	\$ 380.00	FO 2320		7
1958-60	Original Two Tone Top	\$ 760.00	FO 2323		7
	Gold Crest Heatsealed on Quarters (Vinyl Material Only) Add Standard Universal Front Pad Set 75" Black Lining	\$ 280.00 \$ 76.00			



1961-63	Continental Vinyl Curtain Brass Zipper (Color Matched) Standard Universal Front Pad Set 66" Rear Pad Set 30" Black Lining Black Lining	\$ 420.00 \$ 210.00 \$ 70.00 \$ 52.00	FO 3110	22 "	7 2
1964-65	Continental Vinyl Curtain Brass Zipper (Color Matched) Standard Universal Front Pad Set 66" Rear Pad Set 30" Black Lining Black Lining	\$ 420.00 \$ 210.00 \$ 70.00 \$ 52.00	FO 3540	19 1/2"	7 2
1966-67	Continental Standard Universal Front Pad Set 66" Spl Rear Pad Set Two Bottom Strips for Glass are Included Black Lining Black Lining	\$ 420.00 \$ 70.00 \$ 52.00 included	FO 3670		7 2

* Pricing below is for tops only not accessories *

Materials Other than Listed Above or Below, Please Call for Availability and Prices.

Add
for Oe01 or Oe02
Black Lining \$ 44.00

***Add* for Oe or Sa**
Materials Not Listed Above
and/or W/ Tan Lining \$ 100.00

Add
For Stayfast or Topline
St11 and St14 Only \$ 340.00

Add
For Stayfast or Topline (St) Colors
other than St11 and St14 \$ 410.00

"Our Reputation is Tops!"

YEAR	CAR IDENTIFICATION	List Price TR01 , TR02 or TR03	Stock Number	Bow Height	Approx Installation Time
	MERCURY	US Dollars			
1946-48	All Models Vinyl Curtain Brass Zipper (Color Matched) Double Blank Window Brass Zipper (When Purchased with the Top) Standard Universal Front & Rear Pad Set 66" Black Lining	\$ 525.00 \$ 210.00 \$ 230.00 \$ 122.00	FO 0450	20 1/2"	8 2 3
1949-49	All Models Vinyl Curtain Brass Zipper (Color Matched) Double Blank Window Brass Zipper (When Purchased with the Top) Standard Universal Front & Rear Pad Set 75" Black Lining	\$ 525.00 \$ 210.00 \$ 230.00 \$ 128.00	FO 0770	21 1/2?"	8 2 3
1950-51	All Models Vinyl Curtain Brass Zipper (Color Matched) Standard Universal Front & Rear Pad Set 75" Black Lining	\$ 525.00 \$ 210.00 \$ 128.00	FO 1050	21 1/2"	8 2
1952-54	All Models Vinyl Curtain Brass Zipper (Color Matched) Standard Universal Front & Rear Pad Set 75" Black Lining	\$ 525.00 \$ 210.00 \$ 128.00	FO 1720	21 1/2?"	8 2
1955-56	All Models Vinyl Curtain Brass Zipper (Color Matched) Special Front Pad Set Black Lining Special Rear 1/4 Pads Black Lining Note: Rear tack bar has 2 1/2" bolts that get screwed in about 1/2", bar hangs out on end of the bolts	\$ 450.00 \$ 196.00 \$ 78.00 \$ 52.00	FO 1580	19 1/4"	8 2
1957-58	All Models Wrap Around Vinyl Curtain Brass Zipper (Color Matched) Standard Universal Front Pad Set 75" Black Lining Well Black (Cn08)	\$ 525.00 \$ 245.00 \$ 76.00 \$ 220.00	FO 2060	18 "	8 2
1959-60	Monterey, Park Lane Wrap Around Vinyl Curtain Brass Zipper (Color Matched) Standard Front Pad Set 75" Black Lining	\$ 525.00 \$ 245.00 \$ 76.00	FO 2680	19 "	8 3
1961-62	Monterey Vinyl Curtain Brass Zipper (No Bottom Strip) Standard Universal Front Pad Set 66" Black Lining Well Black (Cn08)	\$ 425.00 \$ 196.00 \$ 70.00 \$ 195.00	FO 3100	27 "	6 2
1963-63	Monterey Vinyl Curtain Brass Zipper (No Bottom Strip) Standard Universal Front Pad Set 66" Black Lining Well Black (Cn08) Note: Well Doesn't Have Drain Tubes	\$ 380.00 \$ 182.00 \$ 70.00 \$ 195.00	FO 3290	23 1/4"	6 2
1963-65	Comet, Caliente Vinyl Curtain Brass Zipper (No Bottom Strip) Standard Universal Front Pad Set 60" Black Lining Special Rear 1/4 Pads Black Lining Well Black (Cn08)	\$ 380.00 \$ 182.00 \$ 68.00 \$ 52.00 \$ 195.00	FO 3280	23 1/2"	6 2

* Labor times are based on when the cars were new *

Materials Other than Listed Above or Below, Please Call for Availability and Prices.

Add
for Oe01 or Oe02
Black Lining \$ 44.00

***Add* for Oe or Sa**
Materials Not Listed Above
and/or W/ Tan Lining \$ 100.00

Add
For Stayfast or Topline
St11 and St14 Only \$ 340.00

Add
For Stayfast or Topline (St) Colors
other than St11 and St14 \$ 410.00

LINCOLN MERCURY



Electron Top

YEAR	CAR IDENTIFICATION	US Dollars	Stock Number	Bow Height	Approx Installation Time
Mercury					
1990-92	Capri *Check Measurements* (See Below)				
	Folded Cord on Side Like Original Pe29 or Pe30 \$ 370.00 Matching Binding Above Door Windows Pe29 or Pe30 \$ 350.00 Side Cables (See Cable Pages) \$ 40.00 Rear Lower 1/4 Cables (See Cable Pages) \$ 138.00 Check Top Dimension Vinyl Window Part of Top Suggested Color Pe29 Pe30		FO 4230 FO 4231	19 1/2" Top with Binding	5.5
1993-94	Capri *Check Measurements* (See Below)				
	Folded Cord on Side Like Original Pe29 or Pe30 \$ 370.00 Matching Binding Above Door Windows Pe29 or Pe30 \$ 350.00 Side Cables (See Cable Pages) \$ 40.00 Rear Lower 1/4 Cables (See Cable Pages) \$ 138.00 Check Top Dimension Vinyl Window Part of Top Prod. Date Nov 1992 On Note: Our top does not have heatseal stitching on the quarters - We sew our tops for added strength. Suggested Color Pe29 Pe30 Note: The FO4250 top was used on the 1990-92 car when the upgrade kit was installed by the dealer.		FO 4250 FO 4251	19 1/2" Top with Binding	5.5

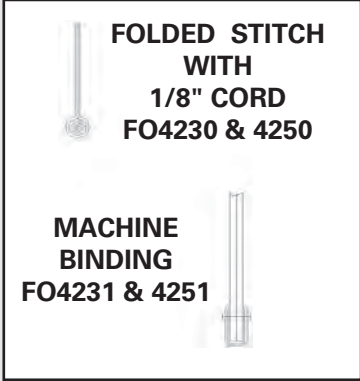
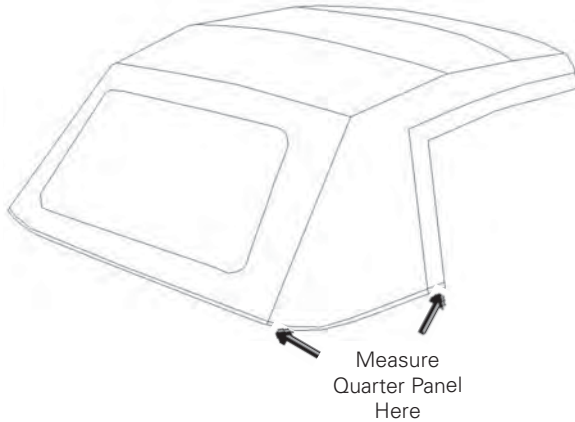

To determine which top you need, please measure lower quarter of top and also top edge above window as shown in drawing above.

Quarter Panel	FO4230 21 1/2 "	FO4250 22 "
----------------------	---------------------------	-----------------------

Sometimes a FO4230 can be stretched to give the wrong dimension.

NOTE: Check the overall fit.

* Pricing below is for tops only not accessories *

Materials Other than Listed Above or Below, Please Call for Availability and Prices.

Add For PE Colors Not Listed Black Lining \$ 44.00	*Add* TO PE29 For OE or Sa Colors Not Listed \$ 100.00	*Add* For Stayfast or Topline St11 and St14 Only \$ 340.00	*Add* For St Colors Not Listed Above \$ 410.00
--	--	--	--

"Our Reputation is Tops!"

MERCURY OLDSMOBILE

YEAR	CAR IDENTIFICATION	List Price TR01 or TR02	Stock Number	Bow Height	Approx Installation Time
	OLDSMOBILE	US Dollars			
1942-48	66 - 68 Vinyl Curtain Brass Zipper (Color Matched) Double Blank Window Brass Zipper (When Purchased with the Top) Standard Universal Front & Rear Pad Set 75" Black Lining	\$ 525.00 \$ 196.00 \$ 230.00 \$ 128.00	GM 0090	20 1/2?"	8 2 3
1948-49	98 Vinyl Curtain Brass Zipper (Color Matched) Double Blank Window Brass Zipper (When Purchased with the Top) Standard Universal Front & Rear Pad Set 75" Black Lining	\$ 525.00 \$ 196.00 \$ 230.00 \$ 128.00	GM 0600	21 1/2?"	8 2 3
1949-49	76 - 88 Vinyl Curtain Brass Zipper (Color Matched) Double Blank Window Brass Zipper (When Purchased with the Top) Standard Universal Front & Rear Pad Set 75" Black Lining	\$ 525.00 \$ 196.00 \$ 230.00 \$ 128.00	GM 0960	21 1/2?"	8 2 3
1950-50	76 - 88 Vinyl Curtain Brass Zipper (Color Matched) Double Blank Window Brass Zipper (When Purchased with the Top) Standard Universal Front & Rear Pad Set 75" Black Lining	\$ 525.00 \$ 196.00 \$ 230.00 \$ 128.00	GM 0970	20 1/2?"	8 2 3
1950-51	98 Rocket Deluxe Vinyl Curtain Brass Zipper (Color Matched) Double Blank Window Brass Zipper (When Purchased with the Top) Standard Universal Front & Rear Pad Set 75" Black Lining Well Black (Cn08)	\$ 525.00 \$ 196.00 \$ 230.00 \$ 128.00 \$ 160.00	GM 1040	19 1/2"	8 2 3
1951-52	88 Rocket Super, 98 Rocket Deluxe Vinyl Curtain Brass Zipper (Color Matched) Standard Universal Front & Rear Pad Set 75" Black Lining	\$ 525.00 \$ 196.00 \$ 128.00	GM 1370	19 1/2"	8 2
1953-53	All Models (Except Fiesta) Vinyl Curtain Brass Zipper (Color Matched) Standard Universal Front & Rear Pad Set 75" Black Lining	\$ 525.00 \$ 196.00 \$ 128.00	GM 1390	18 3/4?"	8 2
1954-56	All Models Vinyl Curtain Brass Zipper (Color Matched) Standard Universal Front & Rear Pad Set 75" Black Lining Well Black (Cn08)	\$ 525.00 \$ 196.00 \$ 128.00 \$ 160.00	GM 1460	19 1/2"	8 2
1957-58	All Models Vinyl Curtain Brass Zipper (Color Matched) Standard Universal Front & Rear Pad Set 75" Black Lining Well Black (Cn08)	\$ 450.00 \$ 196.00 \$ 128.00 \$ 160.00	GM 2030	19 1/4"	8 2
1959-60	88 - 98 Vinyl Curtain Brass Zipper (Color Matched) Standard Universal Front & Rear Pad Set 75" Black Lining Well Black (Cn08)	\$ 400.00 \$ 196.00 \$ 128.00 \$ 160.00	GM 2620	23 "	8 2
1961-64	88 - 98, Starfire Vinyl Curtain Brass Zipper(No Bottom Strip) Spl Front Pad Set Black Lining Well Black (Cn08) Side Cables (See Cable Pages) Universal Glass Window Tinted (Not Warranted) See Note Pg. 15 Note: See Page 15 and Call for Details	\$ 324.00 \$ 182.00 \$ 79.00 \$ 142.00 \$ 116.00 \$ 380.00	GM 3070 ET 1730	25 " 	6 2 3

* Labor times are based on when the cars were new *

Materials Other than Listed Above or Below, Please Call for Availability and Prices.

Add
for Oe01 or Oe02
Black Lining \$ 44.00

***Add* for Oe or Sa**
Materials Not Listed Above
and/or W/ Tan Lining \$ 100.00

Add
For Stayfast or Topline
St11 and St14 Only \$ 340.00

Add
For Stayfast or Topline (St) Colors
other than St11 and St14 \$ 410.00



YEAR	CAR IDENTIFICATION	List Price TR01 or TR02	Stock Number	Bow Height	Approx Installation Time
	Oldsmobile	US Dollars			
1962-63	F 85, Cutlass Vinyl Curtain Brass Zipper (No Bottom Strip) Standard Universal Front Pad Set 60" Well Black	\$ 324.00 \$ 182.00 \$ 68.00 \$ 142.00	GM 3150	21 3/4"	6 2
	Black Lining (Cn08)				
1964-65	F 85, Cutlass, 442 Vinyl Curtain Brass Zipper (No Bottom Strip) Standard Universal Front Pad Set 60" Side Cables (See Cable Pages) Well Black	\$ 324.00 \$ 182.00 \$ 68.00 \$ 60.00 \$ 142.00	GM 3410	20 1/2"	6 2
	Black Lining (Cn08)				
1966-67	F 85, Cutlass, 442 Vinyl Curtain Brass Zipper (No Bottom Strip) Standard Universal Front Pad Set 60" Well Black Side Cables (See Cable Pages) Universal Glass Window Tinted (Not Warranted) See Note Pg. 15 Note: See Page 15 and Call for Details	\$ 324.00 \$ 182.00 \$ 68.00 \$ 142.00 \$ 56.00 \$ 380.00	GM 3660 ET 1720	21 3/4"	6 2 3
	Black Lining (Cn08)				
1965-70	88, Starfire, Delmont, Dynamic Vinyl Curtain Brass Zipper (No Bottom Strip) Standard Universal Front Pad Set 66" Well Black Side Cables (See Cable Pages) Glass Window Tinted	\$ 324.00 \$ 182.00 \$ 70.00 \$ 142.00 \$ 50.00 \$ 320.00	GM 6571	27 1/2"	6 2
	Black Lining (Cn08)				
1965-66	Brass Zipper Glass Window Tinted Note: 1965 Model has a 58 1/2" Front Bow Our Top is 1" Wider	\$ 330.00	ET 5000 ET 5009		3 3
1965-70	Olds 98 Vinyl Curtain v (No Bottom Strip) Standard Universal Front Pad Set 66" Well Black Side Cables (See Cable Pages) Glass Window Tinted Brass Zipper	\$ 324.00 \$ 182.00 \$ 70.00 \$ 142.00 \$ 50.00 \$ 320.00	GM 6572	27 1/2"	6 2
	Black Lining (Cn08)				
1965-66	Zipper Glass Window Tinted Note: 1965 Model has a 58 1/2" Front Bow Our Top is 1" Wider	\$ 330.00	ET 5000 ET 5009		3 3



GM 3660 Top

*Compliments of
Terry Mell
1966 Oldsmobile Cutlass*

* Pricing below is for tops only not accessories *

Materials Other than Listed Above or Below, Please Call for Availability and Prices.

Add for Oe01 or Oe02 Black Lining \$ 44.00	*Add* for Oe or Sa Materials Not Listed Above and/or W/ Tan Lining \$ 100.00	*Add* For Stayfast or Topline St11 and St14 Only \$ 340.00	*Add* For Stayfast or Topline (St) Colors other than St11 and St14 \$ 410.00
--	--	--	--

YEAR	CAR IDENTIFICATION	List Price TR01 or TR02	Stock Number	Bow Height	Approx Installation Time
	Oldsmobile	US Dollars			
1968-72	F85, Cutlass Supreme, 442 Vinyl Curtain No Zipper (No Bottom Strip) Spl Front Pad Set Well Black Side Cables (See Cable Pages) Glass Window Tinted Glass Window Tinted with Brass Zipper Suggested Color OE02 TR01 TR02	\$ 324.00 \$ 182.00 \$ 79.00 \$ 142.00 \$ 56.00 \$ 320.00 \$ 330.00	GM 3680 ET 5020 ET 5029	20 1/2"	6 2 3 3
	Black Lining (Cn08)				
1971-75	88 - 98 Vinyl Curtain Plastic Zipper (Color Matched) Spl Webbing Front Pad Set Webbing is 38" long" (See Pad Pages) Well Black Raingutter Original Style Cables for (1971 Only - See Cable Pages) Universal Cables (1972-76 Only - See Cable Pages) Original Style Cables (Left & Right - See Cable Pages) Glass Window Tinted Plastic Zipper Glass Window Tinted with Defroster Plastic Zipper Glass Curtain Clip for Control Arm Suggested Color Oe02 Oe27 Tr01 Tr02	\$ 324.00 \$ 230.00 \$ 80.00 \$ 142.00 \$ 100.00 \$ 116.00 \$ 60.00 \$ 116.00 \$ 360.00 \$ 420.00 \$ 75.00	GM 4730 ET 5040t ET 5040h	26"	8 3 3 3
	(Cn08)				
					
	GM 4730 Top				
	Compliments of Kenny McCombs Convertible Top Man, GA. Zipper Frame GM4730				
1991-95	Cutlass (Cars & Concepts) Vinyl Rear Window (No Headlining on Window) Standard Front Webbing Pad Set 9" x 60" (See Pad Pages) Side Cables (See Cable Pages) Rear 1/4 Cables (See Cable Pages) (Please Specify Headliner Color on Glass) Glass Window Tinted Glass Window Tinted with Defroster Headliner w/ 1/4 Panels - Available in These Colors: Med Grey, Graphite Grey, Adriatic Blue, Med Beige, Ruby Red & Garnet Red * Please see our color chart for headliner colors Suggested Color Oe19 Tr01 Tr02 Ts20 Original Material 1991-95 Pinpoint Vinyl	\$ 340.00 \$ 230.00 \$ 34.00 \$ 82.00 \$ 82.00 \$ 360.00 \$ 430.00 \$ 530.00	GM 4980 ET 5080t ET 5080h		7 3 3

* Labor times are based on when the cars were new *

Materials Other than Listed Above or Below, Please Call for Availability and Prices.

Add
for Oe01 or Oe02
Black Lining \$ 44.00

***Add* for Oe or Sa**
Materials Not Listed Above
and/or W/ Tan Lining \$ 100.00

Add
For Stayfast or Topline
St11 and St14 Only \$ 340.00

Add
For Stayfast or Topline (St) Colors
other than St11 and St14 \$ 410.00



YEAR	CAR IDENTIFICATION	List Price TR01 or TR02	Stock Number	Bow Height	Approx Installation Time
		US Dollars			
PACKARD					
1948-50	All Models Vinyl Curtain Brass Zipper (Color Matched) Double Blank Window Brass Zipper (When Purchased with the Top) Standard Universal Front & Rear Pad Set 75" Black Lining	\$ 525.00 \$ 210.00 \$ 230.00 \$ 128.00	PA 0760		
1951-54	All Models Vinyl Curtain Brass Zipper (Color Matched) Standard Universal Front & Rear Pad Set 75" Black Lining	\$ 525.00 \$ 210.00 \$ 128.00	PA 1230	25 "	
1955-56	All Models Vinyl Curtain Brass Zipper (Color Matched) Standard Universal Front & Rear Pad Set 75" Black Lining Note: Please check Window Size	\$ 525.00 \$ 210.00 \$ 128.00	PA 2150		
PLYMOUTH					
1949-52	All Models Vinyl Curtain Brass Zipper (Color Matched) Double Blank Window Brass Zipper (When Purchased with the Top) Standard Universal Front & Rear Pad Set 75" Black Lining	\$ 525.00 \$ 210.00 \$ 230.00 \$ 128.00	CH 0990	20 3/4"	8 2 3
1953-54	All Models Vinyl Curtain Brass Zipper (Color Matched) Standard Universal Front & Rear Pad Set 75" Black Lining	\$ 525.00 \$ 210.00 \$ 128.00	CH 1410	23 1/2"	8 2
1955-56	All Models (Bound Across Front Bow) Vinyl Curtain Brass Zipper (Color Matched) Standard Universal Front & Rear Pad Set 75" Black Lining	\$ 525.00 \$ 210.00 \$ 128.00	CH 1640	24 1/2"	8 2
1957-58	All Models Vinyl Curtain Horseshoe Brass Zipper (Color Matched) Standard Universal Front Pad Set 66" Black Lining	\$ 475.00 \$ 210.00 \$ 70.00	CH 2130	24 "	8 2
1959-59	All Models Vinyl Curtain Brass Zipper (Color Matched) Standard Universal Front Pad Set 66" Black Lining	\$ 475.00 \$ 210.00 \$ 70.00	CH 2660	24 1/2"	8 2
1960-61	P & R Series, Fury Vinyl Curtain Brass Zipper (No Bottom Strip) Standard Universal Front Pad Set 66" Black Lining	\$ 450.00 \$ 196.00 \$ 70.00	CH 3020	24 1/2"	8 2
1962-62	B Body - Fury, Sports Fury Vinyl Curtain Brass Zipper (No Bottom Strip) Standard Universal Front Pad Set 60" Black Lining	\$ 450.00 \$ 196.00 \$ 68.00	CH 3170	29 1/2"	7 2
1963-63	B Body - Fury, Sports Fury Vinyl Curtain Brass Zipper (No Bottom Strip) Standard Universal Front Pad Set 60" Black Lining	\$ 450.00 \$ 196.00 \$ 68.00	CH 3350	27 "	7 2

* Pricing below is for tops only not accessories *

Materials Other than Listed Above or Below, Please Call for Availability and Prices.

Add
for Oe01 or Oe02
Black Lining \$ 44.00*Add* for Oe or Sa
Materials Not Listed Above
and/or W/ Tan Lining \$ 100.00*Add*
For Stayfast or Topline
St11 and St14 Only \$ 340.00*Add*
For Stayfast or Topline (St) Colors
other than St11 and St14 \$ 410.00

"Our Reputation is Tops!"

YEAR	CAR IDENTIFICATION	List Price TR01, TR02, CN05 or CN06	Stock Number	Bow Height	Approx Installation Time
	Plymouth	US Dollars			
1963-64	A Body - Valiant, Signet (Check Bow Height 26 ") Vinyl Curtain Brass Zipper (No Bottom Strip) Spl Front Pad Set 60" Well Black	\$ 360.00 \$ 196.00 \$ 79.00 \$ 250.00	CH 3400	26 ?	7 2
	Black Lining (Cn08)				
1964-65	B Body - Fury, Sports Fury, Belvedere II, Satellite Vinyl Curtain Brass Zipper (No Bottom Strip) Standard Universal Front Pad Set 60" Note: Has a 62" Windshield	\$ 375.00 \$ 196.00 \$ 68.00	CH 3570	27 "	7 2
	Black Lining				
1965-66	C Body Fury III, Sports Fury Vinyl Curtain Brass Zipper (No Bottom Strip) Standard Universal Front Pad Set 60" Well Black Note: Has a 68" Windshield	\$ 375.00 \$ 196.00 \$ 68.00 \$ 300.00	CH 3520	27 3/4"	7 2
	Black Lining (Cn08)				
1965-66	A Body - Valiant, Signet (Check Bow Height 24.5 ") Vinyl Curtain Brass Zipper (No Bottom Strip) Standard Universal Front Pad Set 60"	\$ 360.00 \$ 196.00 \$ 68.00	CH 3600	24 1/2"	7 2
	Black Lining				
1966-66	B Body - Belvedere II, Satellite Vinyl Curtain Brass Zipper (No Bottom Strip) Standard Universal Front Pad Set 60" Note: Original Material - Crush Grain	\$ 360.00 \$ 196.00 \$ 68.00	CH 4020	25 ?	7 2
	Black Lining				
1967-68	C Body - Fury III, Sports Fury Vinyl Curtain Brass Zipper (No Bottom Strip) Standard Universal Front Pad Set 66" Glass Window Brass Zipper Note: Original Material - Crush Grain	\$ 335.00 \$ 196.00 \$ 70.00 \$ 360.00	CH 3690	29 3/4"	7 2
	Black Lining		ET 2500		3
1967-69	A Body - Barracuda Vinyl Curtain Brass Zipper (Color Matched) Spl Front Pads Side Cables Glass Window Brass Zipper Glass Window (Not Original) Call for Details	\$ 335.00 \$ 196.00 \$ 79.00 \$ 99.00 \$ 360.00	CH 4090	25 1/2"	7 2
	Black Lining		ET 2510		3
1967-70	B Body - Satellite, Belvedere, GTX, Road Runner Vinyl Curtain Brass Zipper (Color Matched) Spl Front Pads Glass Window Brass Zipper Note: Original Material - Crush Grain	\$ 335.00 \$ 210.00 \$ 78.00 \$ 360.00	CH 4170	23 1/2?"	7 2
	Black Lining		ET 2290		3
1969-70	C Body - Fury III, Sports Fury Vinyl Curtain Brass Zipper (Color Matched) Standard Universal Front Pad Set 66" Glass Window Brass Zipper	\$ 345.00 \$ 210.00 \$ 70.00 \$ 360.00	CH 3890	33 1/4"	7 2
	Black Lining		ET 2550		3
1970-71	Barracuda Vinyl Curtain Brass Zipper (No Bottom Strip) Standard Universal Front Pad Set 60" Side Cables Glass Window Brass Zipper Well Black Note: Original Material-Crush Grain	\$ 335.00 \$ 182.00 \$ 68.00 \$ 100.00 \$ 360.00 \$ 250.00	CH 4190	22 1/2"	7 2
	Black Lining (Cn08)		ET 2560		3

* Labor times are based on when the cars were new *

Materials Other than Listed Above or Below, Please Call for Availability and Prices.

Add
for Oe01 or Oe02
Black Lining \$ 44.00

***Add* for Oe or Sa**
Materials Not Listed Above
and/or W/ Tan Lining \$ 100.00

Add
For Stayfast or Topline
St11 and St14 Only \$ 340.00

Add
For Stayfast or Topline (St) Colors
other than St11 and St14 \$ 410.00

PACKARD
PLYMOUTH



YEAR	CAR IDENTIFICATION	List Price TR01 or TR02	Stock Number	Bow Height	Approx Installation Time
		US Dollars			
	Plymouth				
1997-02	Prowler Roadster Heated Glass Window is Part of Top Webbing Pads with Elastic (See Pad Pages) Please Allow 4-5 Working Days for Manufacturing Suggested Color St11 Original Material 1998-02 Stayfast	St11, St13, St14 \$ 1000.00 \$ 40.00	CH 5450	15 1/4"	5
	<div style="border: 3px double black; padding: 5px; width: fit-content; margin: 0 auto;"> <i>Electron Top</i> 2000 Prowler </div>				
	<div style="border: 2px solid black; padding: 10px;"> <p>CH 5450 Top</p>  </div>				
	PONTIAC				
1942-48	All Models Vinyl Curtain Horseshoe Brass Zipper (Color Matched) Double Blank Window Brass Zipper (When Purchased with the Top) Standard Universal Front & Rear Pad Set 75" Black Lining	\$ 525.00 \$ 196.00 \$ 230.00 \$ 128.00	GM 0090	20 1/2"	8 2 3
1949-49	All Models Vinyl Curtain Horseshoe Brass Zipper (Color Matched) Double Blank Window Brass Zipper (When Purchased with the Top) Standard Universal Front & Rear Pad Set 75" Black Lining	\$ 525.00 \$ 196.00 \$ 230.00 \$ 128.00	GM 0960	21 1/2"	8 2 3
1950-52	All Models Vinyl Curtain Horseshoe Brass Zipper (Color Matched) Double Blank Window Brass Zipper (When Purchased with the Top) Standard Universal Front & Rear Pad Set 75" Black Lining	\$ 525.00 \$ 196.00 \$ 230.00 \$ 128.00	GM 0970	20 1/2"	8 2 3
1953-54	All Models Vinyl Curtain Horseshoe Brass Zipper (Color Matched) Standard Universal Front & Rear Pad Set 66" Black Lining	\$ 525.00 \$ 196.00 \$ 122.00	GM 1360	20 1/2"	8 2
	* Pricing below is for tops only not accessories *				

Materials Other than Listed Above or Below, Please Call for Availability and Prices.

Add
for Oe01 or Oe02
Black Lining \$ 44.00

***Add* for Oe or Sa**
Materials Not Listed Above
and/or W/ Tan Lining \$ 100.00

Add
For Stayfast or Topline
St11 and St14 Only \$ 340.00

Add
For Stayfast or Topline (St) Colors
other than St11 and St14 \$ 410.00

"Our Reputation is Tops!"

YEAR	CAR IDENTIFICATION	List Price TR01 or TR02	Stock Number	Bow Height	Approx Installation Time
		US Dollars			
	Pontiac				
1955-57	All Models Vinyl Curtain Horseshoe Brass Zipper (Color Matched) Standard Universal Front & Rear Pad Set 75" Well Black	\$ 450.00 \$ 196.00 \$ 128.00 \$ 160.00	GM 1610	20 1/2"	8 2
	Black Lining (Cn08)				
1958-58	All Models Vinyl Curtain Horseshoe Brass Zipper (Color Matched) Standard Universal Front & Rear Pad Set 75" Well Black	\$ 450.00 \$ 196.00 \$ 128.00	GM 2250	22 "	8 2
	Black Lining (Cn08)				
1959-60	All Models Vinyl Curtain Horseshoe Brass Zipper (Color Matched) Standard Universal Front & Rear Pad Set 75" Well Black	\$ 400.00 \$ 196.00 \$ 128.00 \$ 160.00	GM 2620	23 "	8 2
	Black Lining (Cn08)				
1962-63	Tempest, Lemans Vinyl Curtain Brass Zipper (No Bottom Strip) Standard Universal Front Pad Set 60" Well Black	\$ 324.00 \$ 182.00 \$ 68.00 \$ 142.00	GM 3150	21 3/4"	6 2
	Black Lining (Cn08)				
1961-64	Catalina, Bonneville Vinyl Curtain Brass Zipper (No Bottom Strip) Spl Front Pad Set Side Cables (See Cable Pages) Well Black Universal Glass Window Tinted (Not Warranted) See Note Pg. 15 Note: See Page 15 and Call for Details	\$ 324.00 \$ 182.00 \$ 79.00 \$ 116.00 \$ 142.00 \$ 380.00	GM 3070	25 "	6 2
	Black Lining (Cn08)		ET 1730		3
1964-65	Tempest, Lemans, GTO Vinyl Curtain Brass Zipper (No Bottom Strip) Standard Universal Front Pad Set 60" Side Cables (See Cable Pages) Well Black	\$ 324.00 \$ 182.00 \$ 68.00 \$ 60.00 \$ 142.00	GM 3410	20 1/2"	6 2
	Black Lining (Cn08)				
1965-70	Bonneville, Catalina, Grand Prix Vinyl Curtain Brass Zipper (No Bottom Strip) Standard Universal Front Pad Set 66" Well Black Side Cables (See Cable Pages) Glass Window Tinted	\$ 324.00 \$ 182.00 \$ 70.00 \$ 142.00 \$ 50.00 \$ 320.00	GM 6571	27 1/2"	6 2
	Black Lining (Cn08)		ET 5000		3
1965-66	Glass Window Tinted Brass Zipper Note: 1965 Model has a 58 1/2" Front Bow Our Top is 1" Wider	\$ 330.00	ET 5009		3
1966-67	Tempest, Lemans, GTO Vinyl Curtain Brass Zipper (No Bottom Strip) Standard Universal Front Pad Set 60" Side Cables (See Cable Pages) Well Black Universal Glass Window Tinted (Not Warranted) See Note Pg. 15 Note: See Page 15 and Call for Details	\$ 324.00 \$ 182.00 \$ 68.00 \$ 56.00 \$ 142.00 \$ 380.00	GM 3660	21 3/4"	6 2
	Black Lining (Cn08)		ET 1720		3

* Labor times are based on when the cars were new *

Materials Other than Listed Above or Below, Please Call for Availability and Prices.

Add
for Oe01 or Oe02
Black Lining \$ 44.00

***Add* for Oe or Sa**
Materials Not Listed Above
and/or W/ Tan Lining \$ 100.00

Add
For Stayfast or Topline
St11 and St14 Only \$ 340.00

Add
For Stayfast or Topline (St) Colors
other than St11 and St14 \$ 410.00

PLYMOUTH PONTIAC



YEAR	CAR IDENTIFICATION	List Price TR01 or TR02	Stock Number	Bow Height	Approx Installation Time
	Pontiac	US Dollars			
1968-72	Tempest, GTO, Lemans	\$ 324.00	GM 3680	20 1/2"	6
	Vinyl Curtain (No Bottom Strip)	\$ 182.00			2
	Special Front Pad Set	\$ 79.00			
	Well Black	\$ 142.00			
	Side Cables (See Cable Pages)	\$ 56.00			
	Glass Window Tinted	\$ 320.00	ET 5020		3
	Glass Window Tinted Brass Zipper	\$ 330.00	ET 5029		3
	Suggested Color Oe02 Tr01 Tr02				
1967-69	Firebird, Trans Am (Vinyl Curtain Model)	\$ 324.00	GM 3720	22 1/2"	6
	Vinyl Curtain (No Bottom Strip) No Zipper	\$ 182.00			
	Vinyl Curtain (No Bottom Strip) Brass Zipper (Non-Original)	\$ 196.00			2
	Standard Universal Front Pad Set 60"	\$ 68.00	Black Lining		
	Side Cables (See Cable Pages)	\$ 64.00			
	Well Black	\$ 142.00	(Cn08)		
	Note: For Glass Window use GM 3740				
1967-69	Firebird, Trans Am (Glass Curtain Model)	\$ 370.00	GM 3740	22 1/2"	7
	Standard Universal Front Pad Set 60"	\$ 68.00	Black Lining		
	Side Cables (See Cable Pages)	\$ 64.00			
	Well Black	\$ 142.00	(Cn08)		
	Note: Glass Window Tinted (Non Hinged Glass)	\$ 400.00	ET 2490		3
	Note: Uses glass from Et2570				
	Note: (Glass window is not warranted) *Call for details				
1971-75	Grand Prix, Bonneville, Catalina, Granville	\$ 324.00	GM 4730	26"	8
	Vinyl Curtain Plastic Zipper (Color Matched)	\$ 230.00			3
	Spl Webbing Front Pad Set Webbing is 38" Long (See Pad Pages)	\$ 80.00			
	Well Black	\$ 142.00	(Cn08)		
	Raingutter	\$ 100.00			
	Original Style Cables for (1971 Only - See Cable Pages)	\$ 116.00			
	Universal Cables (1972-76 Only - See Cable Pages)	\$ 60.00			
	Original Style Cables (Left & Right - See Cable Pages)	\$ 116.00			
	Glass Window Tinted Plastic Zipper	\$ 360.00	ET 5040t		3
	Glass Window Tinted with Defroster Plastic Zipper	\$ 420.00	ET 5040h		3
	Glass Curtain Clip for Control Arm	\$ 75.00			
	Suggested Color Oe02 Oe27 Tr01 Tr02				



GM 3680 Top

**Compliments of
Kenny McCombs
Convertible Top Man, GA.
1972 GTO**

* Pricing below is for tops only not accessories *

Materials Other than Listed Above or Below, Please Call for Availability and Prices.

Add
for Oe01 or Oe02
Black Lining \$ 44.00

***Add* for Oe or Sa**
Materials Not Listed Above
and/or W/ Tan Lining \$ 100.00

Add
For Stayfast or Topline
St11 and St14 Only \$ 340.00

Add
For Stayfast or Topline (St) Colors
other than St11 and St14 \$ 410.00

"Our Reputation is Tops!"

YEAR	CAR IDENTIFICATION	List Price TR01 or TR02	Stock Number	Bow Height	Approx Installation Time
		US Dollars			
	Firebird				
1987-88	Firebird (A.S.C.) *You Must ID Top With Diagram Below* 9" Webbing Pads 60" (See Pad Pages) Side Cables (See Cable Pages) Note: See Diagram Below for Dimension Note: (Frames have an issue that can damage the top.) Suggested Color St11 Tr01	\$ 475.00 \$ 34.00 \$ 58.00	GM 3820		6
1988-91	Firebird (A.S.C.) *You Must ID Top With Diagram Below* 9" Webbing Pads 60" (See Pad Pages) Side Cables (See Cable Pages) Note: See Diagram Below for Dimension Note: (Frames have an issue that can damage the top.) Suggested Color St11 Tr01	\$ 475.00 \$ 34.00 \$ 58.00	GM 3830		6
1990-93	Firebird (A.S.C.) *You Must ID Top With Diagram Below* 9" Webbing Pads 60" (See Pad Pages) Headliner Available in Black Cloth, (Two Pieces) Side Cables (See Cable Pages) Note: See Diagram Below for Dimension Note: (Frames have an issue that can damage the top.) Suggested Color St11 Tr01	\$ 475.00 \$ 34.00 \$ 346.00 \$ 58.00	GM 3850		6

PONTIAC FIREBIRD

Note:

1987-89 GM3820 - under 51" binding to binding Center deck measure about 41" just in front of rear bow.

1988-91 GM 3830 - over 51 1/2" binding to binding Center deck measure about 41" just in front of rear bow.

1990-93 GM 3850 - over 50 1/2" under 52" binding to binding Center deck measure about 44" just in front of rear bow.

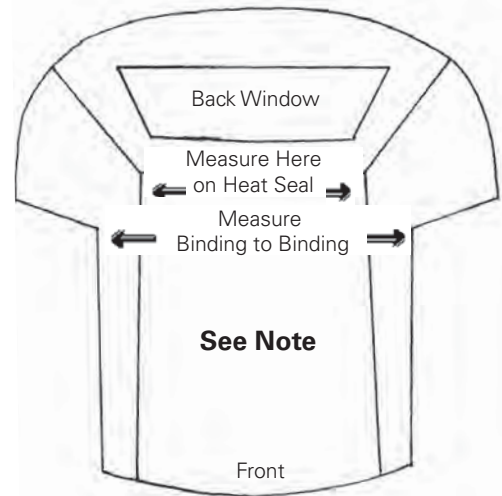

1994-04	Firebird, Trans Am Vinyl Curtain (Color Matched) 6" Webbing Front Pad Set 55" (See Pad Pages) Side Cables (See Cable Pages - Please order 23" or 29") Glass Window Tinted Only Glass Window Tinted W/Defroster Headliner Available, Black Cloth (One Piece) Extrusion to be transferred to new headliner from old Suggested Color St11 St14 St21 Ts20 Original Material 1994-04 Pinpoint Vinyl, Stayfast	\$ 360.00 \$ 420.00 \$ 600.00 \$ 196.00 \$ 28.00 \$ 58.00 \$ 366.00 \$ 430.00 \$ 345.00	GM 3860 ET 3860t ET 3860h	23 " 	7 2 3 3
---------	--	---	---	--------------------------------------	--

* Labor times are based on when the cars were new *

Materials Other than Listed Above or Below, Please Call for Availability and Prices.

Add for Oe01 or Oe02 Black Lining \$ 44.00	*Add* for Oe or Sa Materials Not Listed Above and/or W/ Tan Lining \$ 100.00	*Add* For Stayfast or Topline St11 and St14 Only \$ 340.00	*Add* For Stayfast or Topline (St) Colors other than St11 and St14 \$ 410.00
---	---	---	---



YEAR	CAR IDENTIFICATION	List Price TR01 or TR02	Stock Number	Bow Height	Approx Installation Time
Pontiac					
1983-87	Sunbird Vinyl Curtain Plastic Zipper (Color Matched) 9" Webbing Front Pad Set 55" (See Pad Pages) Side Cables (See Cable Pages) Rear Quarter Cables (See Cable Pages) Well Black Suggested Color OE02 OE11 Tr01 Tr02	US Dollars \$ 324.00 \$ 196.00 \$ 28.00 \$ 58.00 \$ 58.00 \$ 160.00	GM 4870	21 1/2"	6 2
1988-92?	Sunbird (Wireon on Rear Bow) Vinyl Curtain Plastic Zipper (No Bottom Strip) 9" Webbing Front Pad Set 60" (See Pad Pages) Side Cables (See Cable Pages) Rear Quarter Cables (See Cable Pages) Well Black Note: Top was used for earlier production in 1992. Bow height is from bottom tack rail to middle of top bow. Suggested Color Oe02 Oe11 Oe16 Tr01 Tr02	\$ 324.00 \$ 182.00 \$ 34.00 \$ 58.00 \$ 58.00 \$ 160.00	GM 4910	26 1/4"	6 2
1992-93?	Sunbird (Top Wraps Around Front Header Bow) Vinyl Curtain (Color Matched) 9" Webbing Front Pad Set 60" (See Pad Pages) Rear Webbing Pads with Elastic Part of Top Side Cables (See Cable Pages) Rear Quarter Cables (See Cable Pages) Well Black Glass Window Tinted Glass Window Tinted W/Defroster Note: Glass is Attached to Rear Bow with Extrusion. Suggested Color Tr01 Tr02	\$ 324.00 \$ 196.00 \$ 34.00 included \$ 58.00 \$ 58.00 \$ 160.00 \$ 310.00 \$ 380.00	GM 4970	27 "	6.5 3 3
1993-94	Sunbird (Front Bow Pocket White Top has Black Binding) Ts20 Note: Top is Bound Across Front Bow Vinyl Curtain (Color Matched) Uses a Gm 4970 Vinyl 9" Webbing Front Pad Set 60" (See Pad Pages) Rear Webbing Pads with Elastic Part of Top Side Cables (See Cable Pages) Rear Quarter Cables (See Cable Pages) Well Black Glass Window Tinted Glass Window Tinted W/Defroster Note: Attached to Rear Bow with Extrusion Suggested Color Tr01 Tr02 Ts20 Original Material Pinpoint Vinyl	\$ 324.00 \$ 400.00 \$ 196.00 \$ 34.00 included \$ 58.00 \$ 58.00 \$ 160.00 \$ 310.00 \$ 380.00	GM 5060	27 "	6.5 3 3
1995-98	Sunfire (White Top has Black Binding) Tr01 Ts20 Vinyl Curtain (Color Matched) 6" Webbing Front Pad Set 60" (See Pad Pages) Rear Webbing Pads Part of Top Side Cables (See Cable Pages) Rear Quarter Cables (See Cable Pages) Headliner Available Graphite Glass Window Tinted Glass Window W/Defroster Note: Attached to Rear Bow with Extrusion Suggested Color Tr01 Ts20 Original Material 1995-98 1/2 Sailcloth Vinyl Note: See Manufacturers TSB'S on our Website	\$ 324.00 \$ 400.00 \$ 196.00 \$ 30.00 included \$ 70.00 \$ 58.00 \$ 345.00 \$ 310.00 \$ 380.00	GM 5070	27 1/2"	6.5 3 3

* Pricing below is for tops only not accessories *

Materials Other than Listed Above or Below, Please Call for Availability and Prices.

Add
for Oe01 or Oe02
Black Lining \$ 44.00

***Add* for Oe or Sa**
Materials Not Listed Above
and/or W/ Tan Lining \$ 100.00

Add
For Stayfast or Topline
St11 and St14 Only \$ 340.00

Add
For Stayfast or Topline (St) Colors
other than St11 and St14 \$ 410.00

YEAR	CAR IDENTIFICATION	List Price TR01 or TR02	Stock Number	Bow Height	Approx Installation Time
	Pontiac	US Dollars			
1999-00	Sunfire (White top has black binding) Sa13 Se27 or Se28 Vinyl Curtain (Color Matched) 6" Webbing Pads 60" (See Pad Pages) Rear Webbing Pads Part of Top Side Cables (See Cable Pages) Headliner Available Graphite Glass Window Tinted Glass Window Tinted W/Defroster Note: Attached to Rear Bow with Extrusion Original Material Sailcloth Vinyl Note: See Manufacturers TSB'S on our Website	\$ 324.00 \$ 400.00 \$ 196.00 \$ 30.00 included \$ 70.00 \$ 345.00 \$ 310.00 \$ 380.00	GM 5090 ET 5070t ET 5070h	27 1/2? 3 3	6 3 3
	RAMBLER	See Renault Page 97			
1948-48	Ambassador Vinyl Curtain Brass Zipper (Color Matched) Double Blank Window Brass Zipper (When Purchased with the Top) Standard Universal Front & Rear Pad Set 75"	\$ 525.00 \$ 196.00 \$ 230.00 \$ 128.00	NA 0330		2 3
1961-62	American Vinyl Curtain Brass Zipper (Color Matched) Standard Universal Front Pad Set 66"	\$ 475.00 \$ 196.00 \$ 70.00	NA 3120	19 1/2"	2
1963-63	American Vinyl Curtain Brass Zipper (Color Matched) Standard Universal Front Pad Set 66"	\$ 400.00 \$ 196.00 \$ 70.00	NA 3300	19 1/2"	2
1964-67	American 440, Rouge Vinyl Curtain Brass Zipper (No Bottom Strip) Special Front Pad Set Special Rear Pad Set Well Black	\$ 400.00 \$ 182.00 \$ 78.00 \$ 42.00 \$ 250.00	NA 3320	22 "	2
1965-66	Classic, Ambassador (Vinyl Curtain Model) Vinyl Curtain Brass Zipper (No Bottom Strip) Standard Universal Front Pad Set 66"	\$ 400.00 \$ 182.00 \$ 70.00	NA 3360	24 ?	8 2
1966-66	Classic, Ambassador (Glass Curtain Model) Vinyl Curtain Brass Zipper (Color Matched) Standard Universal Front Pad Set 66"	\$ 380.00 \$ 196.00 \$ 70.00	NA 3390	24 ?	8 2
1967-68	Rebel, Ambassador Vinyl Curtain Brass Zipper (Color Matched) Special Front Pad Set Note: Glass Window (Customer Must Supply Glass)	\$ 380.00 \$ 196.00 \$ 88.00 \$ 360.00	NA 3730 ET 2300	29 1/2? 3	8 2 3

* Labor times are based on when the cars were new *

Materials Other than Listed Above or Below, Please Call for Availability and Prices.

Add
for Oe01 or Oe02
Black Lining \$ 44.00

***Add* for Oe or Sa**
Materials Not Listed Above
and/or W/ Tan Lining \$ 100.00

Add
For Stayfast or Topline
St11 and St14 Only \$ 340.00

Add
For Stayfast or Topline (St) Colors
other than St11 and St14 \$ 410.00

PONTIAC

RAMBLER



YEAR	CAR IDENTIFICATION	US Dollars	Stock Number	Bow Height	Approx Installation Time
Sport Utility Vehicles					
1988-94	Geo Tracker Colors (Blk Denim)	\$ 736.00	BT 51362		
1995-98	Geo Tracker Colors (Black)	\$ 1044.00	BT 51364		
1999-02	Geo Tracker & Vitara Colors (Black Only)	\$ 1182.00	BT 51366		
1988-94	Suzuki Sidekick (Blk Denim)	\$ 736.00	BT 51362		
1995-98	Suzuki Sidekick (Black Only)	\$ 1044.00	BT 51364		
1998-02	Isuzu Amigo (Blk Pigskin Only)	\$ 1352.00	BT 51157		
1988-95	Wrangler (Almond, Blk, Khaki & Spice Denim) Includes Half Door Skins	\$ 1234.00	BT 51120		
1997-02	Wrangler (Blk Denim & Spice) Includes Half Door Skins	\$ 1624.00	BT 51121		
2003-06	Wrangler (Blk Diam. & Khaki Diam.) Includes Half Door Skins	\$ 1648.00	BT 51128		
2003-06	Wrangler (Blk Diam. & Khaki Diam.) Fits Full Steel Door Models	\$ 1354.00	BT 51178		
2007-09	Wrangler 2 Door (Blk Diam. & Khaki Diam.) Fits Full Steel Door Models	\$ 1916.00	BT 79136		
2010-13	Wrangler 2 Door (Blk Diam. & Khaki Diam.) Fits Full Steel Door Models	\$ 1940.00	BT 79142		
2012-13	4 Door Jeep (Omix Powered Frame Top with Vinyl Window)	\$ 1500.00	JE 3920		



**Omix Powered Frame Top
By Electron Top**

* Pricing below is for tops only not accessories *

For Colors and Materials Other than Listed Above, Call for Availability and Price.

"Our Reputation is Tops!"

YEAR	CAR IDENTIFICATION	List Price TR01 or TR02	Stock Number	Bow Height	Approx Installation Time
	STUDEBAKER	US Dollars			
1946-52	All Models	\$ 450.00	SU 0800	23 "	2
	Vinyl Curtain Brass Zipper (Color Matched)	\$ 210.00			
	Double Blank Window Brass Zipper (When Purchased with the Top)	\$ 230.00			
	Standard Universal Front & Rear Pad Set 85" Black Lining	\$ 134.00			
1960-60	Lark	\$ 400.00	SU 2940	22 ?	2
	Vinyl Curtain Brass Zipper (Color Matched)	\$ 210.00			
	Standard Universal Front Pad Set 66" Black Lining	\$ 70.00			
1961-64	Lark	\$ 400.00	SU 3200	24 3/4"	2
	Vinyl Curtain Brass Zipper (Color Matched)	\$ 210.00			
	Standard Universal Pad Set 66" Black Lining	\$ 70.00			
	Special Rear Pad Set Black Lining	\$ 52.00			



*Compliments of
Kenny McCombs
Convertible Top Man, GA.*

* Labor times are based on when the cars were new *

Materials Other than Listed Above or Below, Please Call for Availability and Prices.

**Add*
for Oe01 or Oe02
Black Lining \$ 44.00*

**Add* for Oe or Sa
Materials Not Listed Above
and/or W/ Tan Lining \$ 100.00*

**Add*
For Stayfast or Topline
St11 and St14 Only \$ 340.00*

**Add*
For Stayfast or Topline (St) Colors
other than St11 and St14 \$ 410.00*



YEAR	CAR IDENTIFICATION	List Price TR01, TR02 or TR03	Stock Number	Bow Height	Approx Installation Time
	THUNDERBIRD	US Dollars			
1955-57	2 Passenger <p style="text-align: right;">St11 or St14</p> Vinyl Curtain Straight Brass Zipper (Color Matched) 2" Webbing Supplied For Bow Straps The original 1956 top had a built in horseshoe zipper window. The teeth were exposed to the elements with a moulded rubber lip covering the teeth, it leaked badly. In the same year the window assm. was made separate and a straight zipper was used. WE produce the newer style.	\$ 324.00 \$ 600.00 \$ 196.00 included	FO 1600	19 "	5 2
1958-60	4 Passenger Vinyl Curtain Brass Zipper (Color Matched) Spl Front Pad Set Rear 1/4 Pads Part of Top Bow height measure to bottom of the bar <p style="text-align: right;">Black Lining</p>	\$ 450.00 \$ 210.00 \$ 79.00 included	FO 2310	20 1/2?	7 2
1961-63	4 Passenger (Bow Height Measure to Body of Car) Vinyl Curtain Brass Zipper (Color Matched) Spl Front Pad Set Spl Rear Pad Set <p style="text-align: right;">Black Lining Black Lining</p>	\$ 380.00 \$ 210.00 \$ 79.00 \$ 44.00	FO 3090	23 1/2"	7 2
1964-66	4 Passenger Vinyl Curtain Brass Zipper (Color Matched) Special Front Pad Set Spl Rear Pad Set (Use FO3090) Note: Bow Height Must Be Measured From the Center of the Rear Bow Down to the Center of the Bottom Strip. <p style="text-align: right;">Black Lining Black Lining</p>	\$ 380.00 \$ 196.00 \$ 85.00 \$ 44.00	FO 3460	22 1/2"	7 2
2001-05	2 Passenger <p style="text-align: right;">St24 Sg26</p> Glass Window Tinted W/Defroster Glass Window Tinted W/Defroster Side Cables (See Cable Pages) Headliner Available Black (2002-05) Original Material 2001-05 Twillfast <p style="text-align: right;">Plain Blk Lining Herringbone Lining</p>	\$ 725.00 \$ 775.00 \$ 336.00 \$ 530.00 \$ 94.00 \$ 408.00	FO 4330	23?	7 3 3



*Compliments of
Kenny McCombs
Convertible Top Man, GA.
1964 Ford Thunderbird
FO 3460*

* Pricing below is for tops only not accessories *

Materials Other than Listed Above or Below, Please Call for Availability and Prices.

Add
for Oe01 or Oe02
Black Lining \$ 44.00

***Add* for Oe or Sa**
Materials Not Listed Above
and/or W/ Tan Lining \$ 100.00

Add
For Stayfast or Topline
St11 and St14 Only \$ 340.00

Add
For Stayfast or Topline (St) Colors
other than St11 and St14 \$ 410.00

YEAR	CAR IDENTIFICATION	List Price TR01	Stock Number	Approx Installation Time
	ALFA ROMEO	US Dollars		
1956-59	Spyder Giulietta <i>Note:</i> This top is fastened to #1 & #2 bows as well as front & rear bows. #1 & #2 bows are closer together at the center than they are at the sides and the rear bar hooks on to the rear deck	\$ 650.00	AL 2580	5.0
1959-63	Spyder 2000 <i>Note:</i> Center deck & rear curtain are one piece	\$ 650.00	AL 2740	5.0
1960-60	Spyder <i>Note:</i> Rear bar bolts on to rear deck	\$ 650.00	AL 6230	
1961-61	Spyder <i>Note:</i> An extra wide flap extends from the rear bow to the front bow on the inside, it gives the appearance of a headliner	\$ 650.00	AL 6400	
1962-63	Spyder <i>Note:</i> The forward edge of the side quarters might be riveted to a plate that extends down from the top frame just behind the windshield post	\$ 650.00	AL 6290	5.0
1963-64	Spyder <i>Note:</i> This top has a special rubber extrusion fastened to the top above the side window (Extrusion Not Supplied)	\$ 650.00	AL 6510	5.0
1964-68	2600 - Roadster <i>Note:</i> Top has a zipper curtain, headliner and padded bows	\$ 900.00	AL 7109	5.5
1965-66	Spyder <i>Note:</i> This top is the same as 1964, but has a padded rubber and velvet cushion under the side flaps in place of a rubber extrusion, a metal clip is riveted in between the flap and the top in the front	\$ 650.00	AL 7070	
1967-70	1600 - 1750 Duetto Spyder <i>Note:</i> This top has padded quarters and a 38" wide rear window with a vertical seam down each side	\$ 540.00 St11, St14 \$ 880.00	AL 7140	5.0
1971-94	1750 - 2000 Spyder <i>Note:</i> This top has padded quarters and a rear bow seam from side to side <i>Note:</i> Will only make top with black lining Suggested Colors TR01 ST11 ST14	\$ 590.00 St11, St14 \$ 930.00	AL 7250	4.5
1995-03	Spyder Original Material 1997 Stayfast 2000-05 Stayfast & Twillfast	Request		

* Labor times are based on when the cars were new *

Materials Other than Listed Above or Below, Please Call for Availability and Prices.

Add
For Pinpoint OE Colors
Black Lining \$ 44.00

Add
For Pinpoint OE Colors
Tan Lining \$ 100.00

Add
For Stayfast or Topline
ST11 and ST14 Only \$ 340.00

Add
For Stayfast or Topline ST Colors
and/or with Tan Lining \$ 440.00



YEAR	CAR IDENTIFICATION	List Price TR01 or TR02	Stock Number	Approx Installation Time
	AMPHICAR	US Dollars		
1963-67	Amphicar (Amphibious Model) Boot Cover Life Preservers Are NEEDED! Note: Top has a zipper window	\$ 520.00 \$ 190.00	AP 3139	4.0
<div data-bbox="175 554 1084 1272" data-label="Image"> </div>				
	ASTON MARTIN			
1965-??	DB 5 ** Top may be available as a special order ** ** Please call for information **	Call	AS 6710	
1965-97	DB 6 ** Top may be available as a special order ** ** Please call for information ** Original Material 1997-03 Twillfast	Call	AS 6970	
2010-on	DB 9	Call		

* Pricing below is for tops only not accessories *

Materials Other than Listed Above or Below, Please Call for Availability and Prices.

Add
For Pinpoint OE Colors
Black Lining \$ 44.00

Add
For Pinpoint OE Colors
Tan Lining \$ 100.00

Add
For Stayfast or Topline
ST11 and ST14 Only \$ 340.00

Add
For Stayfast or Topline ST Colors
and/or with Tan Lining \$ 440.00

YEAR	CAR IDENTIFICATION		US Dollars	Stock Number	Approx Installation Time
	AUDI				
1992-98	Audi Cabriolet (No Zipper) Headliner Available in Black Cloth (1994-98) Note: Original style green tinted window. Made without replaceable zipper window Original Material 1996-98 Twillfast	Sg11, Sg13 Gr11, Gr13	\$ 1050.00 \$ 1250.00 \$ 620.00	AD 5150	8.0
2000-06	Audi TT Roadster (Glass Window Tinted with Defroster) Side Cables (See Cable Pages) Original Material 2000-05 Twillfast 2006 Sonnenland, Twillfast	Sg11, Sg13 Gr11, Gr13	\$ 1110.00 \$ 1310.00 \$ 93.00	AD 5190	8.0
2003-09	Audi A4 & S4 Cabriolet, Quattro (Heated Glass Window) Top has zipper listings and plastic retainers. Top has Window Brackets to Attach Headliner Original Material 2003-07 Sonnenland A5	Sg11, Sg13 Gr11, Gr13	\$ 1385.00 \$ 1685.00	AD 5160	8.0
2008-13	Audi TT Roadster (Glass Window Tinted with Defroster)		Call		
2009-13	Audi S5 Cabriolet		Call		
2010-13	Audi R8 Spyder		Call		



2000-2006
Audi TT
AD5190

* Labor times are based on when the cars were new *

Materials Other than Listed Above or Below, Please Call for Availability and Prices.

Add
To SG11 For SG Colors
Not Listed \$ 100.00

Add
To GR11 For GR Colors
Not Listed \$ 100.00



Electron Top

YEAR	CAR IDENTIFICATION	List Price TR01 or IB11	Stock Number	Approx Installation Time
		US Dollars		
	AUSTIN HEALEY			
1953-56	100 BN 1 & BN 2 (2 Passenger) Note: Rear bar hooks to trunk deck	\$ 660.00	AU 2380	5.0
1957-59	100 BJ 2 (4 Passenger) Note: Rear bar hooks to trunk deck	\$ 660.00	AU 2490	7.0
1957-59	100-6 BJ 4 (4 Passenger) Note: Top attaches to body with snap fasteners	\$ 660.00	AU 2510	7.0
1957-59	100-6 BN 4 (2 Passenger) Note: Top attaches to body with snap fasteners	Request		
1959-62	3000 BJ 4 (4 Passenger) Note: Top attaches to body with snap fasteners	\$ 660.00	AU 6270	7.0
1959-62	3000 (2 Passenger) Note: Rear bar hooks to the trunk deck	\$ 760.00	AU 6430	7.0
1963-68	3000 MKII, MKIII, BJ 7 & BJ 8 (4 Passenger) Note: Top has a zipper rear window	\$ 600.00	AU 6669	7.0
1963-65	Innocenti	\$ 650.00	AU 7060	
1958-59	Sprite Note: Top attaches to windshield with nine DOT fastener	\$ 550.00	AU 6070	4.0
1959-61	Sprite Note: Top attaches to windshield with a thin metal strip and a DOT fastener on each side	\$ 550.00	AU 6220	4.0
1961-64	Sprite MKII	\$ 550.00	AU 6310	4.0
1964-67	Sprite MKIII Note: Top has a rear bar	\$ 500.00	AU 7020	4.0
1967-70	Sprite MKIV Note: Top attaches to the body with a chrome molding and stud. Needs: 6 Tenax sockets and plates (Can reuse old ones)	\$ 500.00 \$ 12.00 ea	AU 7090	4.0

* Pricing below is for tops only not accessories *

Materials Other than Listed Above or Below, Please Call for Availability and Prices.

Add
For Pinpoint OE Colors
Black Lining \$ 44.00

Add
For Pinpoint OE Colors
Tan Lining \$ 100.00

Add
For Stayfast or Topline
ST11 and ST14 Only \$ 340.00

Add
For Stayfast or Topline ST Colors
and/or with Tan Lining \$ 440.00

YEAR	CAR IDENTIFICATION		US Dollars	Stock Number	Approx Installation Time
1987-93	<div style="border: 1px solid black; padding: 5px; display: inline-block;">BMW</div> 318i, 320i, 325i Manual Frame Model (No Zipper) Cables Front Retaining Strip Tension Straps when purchased without top Tension Straps when purchased with top Vinyl window is tinted green Note: Must reuse OEM Rods on Tension Straps. See Tension Strap Warning Below Original Material 1987-91 Sonnenland 1992 Sonnenland & Twillfast 1993 Twillfast	Sg11, Sg13	\$ 800.00	BM 8090	7.0
		Gr11, Gr13	\$ 900.00		
1991-93	318i, 320i, 325i Power Frame Model (No Zipper) Side Cables Front Retaining Strip Tension Straps when purchased without top Tension Straps when purchased with top Note: This top has brushes on the rear quarters like the original Note: Must reuse OEM Rods on Tension Straps. See Tension Strap Warning Below Suggested Colors GR11, GR12, GR13 Original Material 1991 Sonnenland 1992 Sonnenland & Twillfast 1993 Twillfast	Sg11, Sg13	\$ 800.00	BM 8091	7.0
		Gr11, Gr13	\$ 900.00		

Compliments of Tommy
Sunrise Auto Uph
NY.
BM 8090 Top



BM8090 Straps



"Tension Strap Warning"

A problem has been occurring with the 1987-1999 BMW "i" Series convertible tops. The issue is that the frame pinches and/or tears the top near the bows and sometimes the side quarters. The tension straps should be replaced when installing a new top.

* Labor times are based on when the cars were new *

Materials Other than Listed Above or Below, Please Call for Availability and Prices.

Add
To SG11 For SG Colors
Not Listed \$ 100.00

Add
To GR11 For GR Colors
Not Listed \$ 100.00

AUUSTIN BMW



YEAR	CAR IDENTIFICATION	US Dollars	Stock Number	Approx Installation Time	
BMW					
1994-99	318i, 323i, 325i, 328i, M3 (No Zipper)	Sg11, Sg13	\$ 940.00	BM 8110	8.0
	Front Retaining Strip		\$ 154.00		
	Tension Straps when purchased without top		\$ 240.00		1.0
	Tension Straps when purchased with top		\$ 200.00		
	Note: See Tension Strap Warning Below.				
	Headliner Available Charcoal Ribbed				
	1994-97 (3) Plastic snap on bows, manual lock & windlace at front, no pocket		\$ 670.00	BM 8110	
	1997-99 (2) Plastic snap on bows, electric lock & pocket in front for metal piece		\$ 670.00	BM 8111	
	1997-99 (2) Plastic snap on bows, manual lock & windlace on front, no pocket		\$ 670.00	BM 8112	
	1997 Only (3) Plastic snap on bows, electric lock & pocket in front for metal piece		\$ 670.00	BM 8113	
String Kit for Headliner (Instructions are included) BMW 54 318 189 989		\$ 276.00pr			
Stiffener Kit for Headliner (Instructions are included) BMW 54 318 211 902		\$ 90.00pr			
Side Cables		\$ 52.00			
Note: Made Without Relief Patch & Window Zipper					
Suggested Colors SG11 SG12 SG14					
Original Material 1994-99 Sonnendecke					
1996-02	Z3, M Roadster (No Zipper With Pockets)	Sg11, Sg27	\$ 780.00	BM 8120	9.0
	Z3, M Roadster (No Zipper Without Pockets)	Sg11, Sg27	\$ 680.00	BM 8121	9.0
	Butyl Rubber		\$ 25.00		
	Headliner Available Charcoal Ribbed		\$ 670.00		
Side Cable Repair Kit		\$ 102.00			
Note: Vinyl window is tinted green - Our top is made with flaps instead of extrusions for ease during installation					
Suggested Colors SG11 SG27					
Original Material 1996-02 Sonnendecke					

BM 8110 Straps

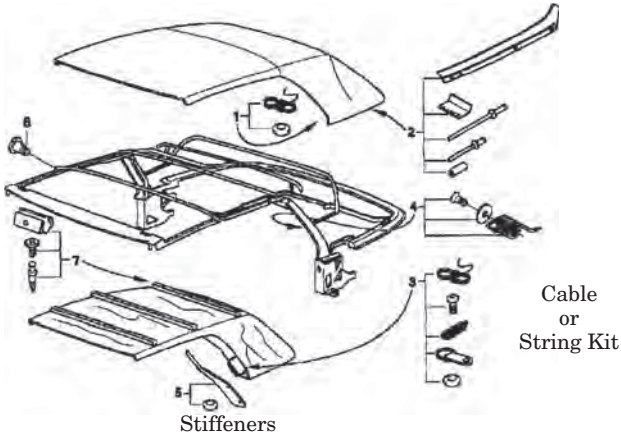

" Tension Strap Warning "

A problem has been occurring with the 1987-1999 BMW "i" Series convertible tops. The issue is that the frame pinches and/or tears the top near the bows and sometimes the side quarters. The tension straps should be replaced when installing a new top.

* Pricing below is for tops only not accessories *

Materials Other than Listed Above or Below, Please Call for Availability and Prices.

Add
To SG11 For SG Colors
Not Listed \$ 100.00

YEAR	CAR IDENTIFICATION	List Price TR01	Stock Number	Approx Installation Time
	BMW	US Dollars		
2000-06	318i, 320i, 323i, 325ci, 330i, M3 Cabriolet (Padded roof) Sg11, Sg13 Headliner Available Black Ribbed Stiffeners with Strings attached Spl webbing pads Note: Tinted Defroster Glass Window. Original Material 2004-07 Sonnendecke	\$ 1600.00 \$ 415.00 \$ 312.00 \$ 315.00	BM 8150	10.0
2000-03	Z8, M, E85 Roadster Green Tinted Plastic Window Headliner included	Call	BM 8130	
2003-08	Z4, M Roadster (Glass Window Heated) Sg11, Sg13 Note: Edge lock body seal Original Material 2004-07 Sonnendecke	\$ 1395.00	BM 8140	7.0
2004-10	630i, 645ci, 650i, M6 Cabriolet (Padded roof) Sg11, Sg13 Note: Glass is part of top frame. Original Material 2004-07 Sonnendecke	\$ 1825.00	BM 8170	10.0
2008-13	128i, 135i E88 Cabriolet Sewn in Plastic Retainers and rain gutter above door window. Metal bracket for headliner	Call	BM 8180	12.0
	CITROEN			
1966-67	Citroen NOTE: Zipper Window has a valance across the rear bow	\$ 820.00	CI 6749	
2002-07	Pluriel Original Material 2004-07 Twillfast RPC	Request		
	DAIMLER			
1962-??	SP 250	\$ 672.00	DM 6280	

* Labor times are based on when the cars were new *

Materials Other than Listed Above or Below, Please Call for Availability and Prices.

Add
For Pinpoint OE Colors
Black Lining \$ 44.00

Add
For Pinpoint OE Colors
Tan Lining \$ 100.00

Add
To SG11 For SG Colors
Not Listed \$ 100.00

BMW
CITROEN
DAIMLER



YEAR	CAR IDENTIFICATION	List Price TR01	Stock Number	Approx Installation Time
		US Dollars		
	DATSUN			
1962-67	** Tops may be available as a special order ** ** Please call for information **	Call		
1962-??	SPL 213	\$ 580.00	DA 6380	6.0
1963-65	SPL 310 "1500 Engine"	\$ 580.00	DA 6670	6.0
1965-65	SPL 310 "1500 Engine" Note: Wire sleeve and four bow straps 42" Centerdeck	\$ 580.00	DA 6700	6.0
1965-67	SPL 311 "1600, 2000 Engine" (3 Windows) Note: Has wide padded flap inside above the doors that attaches to the center deck seam with four snaps 38 3/4" Centerdeck	\$ 580.00	DA 6701	6.0
1967-69	SPL 311 - "1600, 2000 Engine" (3 Windows) Note: Top has wide padded flap inside above the doors that attaches to the center deck seam with five snaps	\$ 580.00	DA 6830	6.0
1968-71	SPL 311 - 2000 (3 Windows) Note: Top has torpedo shaped waterstops above side windows	\$ 580.00	DA 7040	6.0
	DUAL GHIA			
1957-58	** Tops may be available as a special order ** ** Please call for information **	Tr01 \$ 660.00 St11 \$ 1000.00	DU6800	
	FACEL VEGA			
1961-??	** Tops may be available as a special order ** ** Please call for information **	Request		
	FERRARI			
1984-94	Mondial, Quattrovalvole (Inline Engine)	Sg11 \$ 1400.00 Gr11 \$ 1600.00	FR 8050	8.0
1995-99	F 355 Spider	Request		
1993	Mondial T (Transverse Engine)	Sg11 \$ 1400.00 Gr11 \$ 1600.00	FR 8060	8.0

* Pricing below is for tops only not accessories *

Materials Other than Listed Above or Below, Please Call for Availability and Prices.

Add
To Tr01 for OE Colors
Black Lining \$ 44.00

Add
To ST11 For ST Colors
Not Listed \$ 100.00

Add
To SG11 For SG Colors
Not Listed \$ 100.00

Add
To GR11 For GR Colors
Not Listed \$ 100.00

YEAR	CAR IDENTIFICATION	List Price TR01	Stock Number	Approx Installation Time
	FIAT	US Dollars		
1957-58	1100 & 1200 Roadster (2 Passenger)	\$ 500.00	FA 6339	4.0
1958-61	500 (4 Passenger) Note: With window (W-37 1/2" x L-64 1/2")	\$ 716.00	FA 6100	
1958-59	1200 TV Roadster (2 Passenger) Note: Zipper window	\$ 768.00	FA 6179	4.0
1959-59	600 Sunroof Note: Sunroof (W-39 3/4" x L-67 1/4")	\$ 742.00	FA 6320	
1958-58	500 (2 Passenger) Note: With window (W-40 1/4" x L-57 1/2")	\$ 742.00	FA 6410	
1960-66	1200-1500 Roadster (2 Passenger)	\$ 550.00	FA 6030	5.0
1967-73	850 Rear Engine (2 Passenger)	\$ 550.00	FA 6820	5.0
1967-70	Siata	\$ 742.00	FA 6840	5.5
1968-79	124 Roadster 1600, 1800, 2000 (Front bow has square corners) Note: Includes Stiffeners	\$ 510.00	FA 7180	5.0
1979-85	124 Roadster 2000, Pininfarina (Front bow has round corners) Note: Includes Stiffeners	\$ 510.00	FA 7340	5.0
	FA 7180 Square Corner Front Bow FA 7180 Driver Side			
	FA 7340 Round Corner Front Bow FA 7340 Driver Side			
2012-	Fiat 500 Cabrio	Request		
	FORD CONSUL & ZEPHYR			
1958-61	** Tops may be available as a special order ** ** Please call for information **	Request		
	* Labor times are based on when the cars were new *			

DATSUN
DUAL
GHIA
FERRARI
FIAT
FORD

Materials Other than Listed Above or Below, Please Call for Availability and Prices.

Add
For Pinpoint OE Colors
Black Lining \$ 44.00

Add
For Pinpoint OE Colors
Tan Lining \$ 100.00

Add
For Stayfast or Topline
ST11 and ST14 Only \$ 340.00

Add
For Stayfast or Topline ST Colors
and/or with Tan Lining \$ 440.00



YEAR	CAR IDENTIFICATION		US Dollars	Stock Number	Approx Installation Time
	HILLMAN				
1950-67	** Tops may be available as a special order ** ** Please call for information **		Request		
	HONDA				
2000-01	S 2000 Roadster (Vinyl Window is Built into Top)	Ht01, Ht03	\$ 850.00	HO 8300	8.0
		St11	\$ 1010.00		
	Side Cables (Fits 2000-2009) Note: (No Rain Rail)		\$ 156.00		
2000-01	S 2000 Roadster (Upgrade with Glass Window)	Ht01, Ht03	\$ 1025.00	HO 8305	8.0
		St11	\$ 1180.00		
	Side Cables (Fits 2000-2009) Note: (No Rain Rail) Note: This is a conversion top from plastic to glass rear window. The rear bow needs to be moved forward as the top folds. The later model frame has a spring built in to do this. Note: Please Allow 4-5 Working Days for Manufacturing Electron will not be responsible for improper folding or damage to the top or frame. Installer will have to convert frame by adding elastic (included w/top) or cables to bows so it will work like the newer model frame.		\$ 156.00		
2002-09	S 2000 Roadster (Glass Window is Built into Top)	Ht01, Ht03	\$ 940.00	HO 8310	8.0
		St11	\$ 1100.00		
	Note: (No Rain Rail) Side Cables (Fits 2000-2009) Note: Please Allow 4-5 Working Days for Manufacturing Original Material 2002-09 Twill Vinyl		\$ 156.00		
	<i>Watch Video On Installing Honda S2000</i> <i>www.youtube.com/watch?v=xVAjMtIMMiU&feature=youtu.be</i> <i>Video by Kenny McCombs Convertible Top Man, GA.</i>				
		<div style="border: 2px solid black; padding: 5px; text-align: center;"> Compliments of Kenny McCombs Convertible Top Man, GA. 2002 Honda S 2000 </div>			

* Pricing below is for tops only not accessories *

Materials Other than Listed Above or Below, Please Call for Availability and Prices.

***Add* To HT or PE or Oe
Colors Not Listed
Black Lining \$ 44.00**

***Add* To HT
For Oe with
Tan Lining \$ 100.00**

***Add*
To ST11 For ST Colors
Not Listed \$ 100.00**

YEAR	CAR IDENTIFICATION	List Price TR01	Stock Number	Approx Installation Time
	INFINITI	US Dollars		
1989-92	M30 Convertible Vinyl Curtain with Stiffeners Headliner Available Black Note: Top is connected to the rear bow with an extrusion. Bow Height 24 3/4" Suggested Colors ST11 ST12 Original Material 1990-92 Stayfast	St11 \$ 800.00 \$ 240.00 \$ 430.00	IN 7800	8.0 3.0
2011	Infiniti G37	Call		
		<div style="border: 2px solid black; padding: 5px; display: inline-block;"> 1989-92 Infiniti M30 </div>		
	ITALIA			
1967-69	Roadster Note: Round corner on door glass	\$ 660.00	IT 6870	
1970-70	Roadster Note: Nearly square corner on door glass, bound across front bow.	\$ 660.00	IT 7170	

* Labor times are based on when the cars were new *

Materials Other than Listed Above or Below, Please Call for Availability and Prices.

Add
 For Pinpoint OE Colors
 Black Lining \$ 44.00

Add
 For Pinpoint OE Colors
 Tan Lining \$ 100.00

Add
 For Stayfast or Topline
 ST11 and ST14 Only \$ 340.00

Add
 For Stayfast or Topline ST Colors
 and/or with Tan Lining \$ 440.00



JAGUAR CONVERTIBLE TOPS

Our "Classic XK Roadster" (JA1683) convertible top is carefully crafted with the authentic details of the original design. These distinguishing details are hand-folded edges, finished with piping, Brewster-cross seams, and a double blank window with three zippers (for use with a glass and frame).

The "Classic Top" (JA1673) has no rear zippers and is blank (for use with a glass and frame). This is truly a Classic Top! It's a must for Jaguar owners that intend to show their cars. The Classic top is available in Haartz Stayfast or Topline material only.

We realize that many Jaguars are used every day and do not need all the costly original details of the Classic Top. Therefore, we offer a Service Line, a moderately priced top in other materials and colors as well as Stayfast.

The JA1680 has a horseshoe zipper around the back either for a clear vinyl or a blank insert (for use with a glass and frame). **The JA1670** has no zipper and is blank in the rear (for use with a glass and frame). Both tops are machine bound.

DROP HEAD COUPE The original details (not as unique) are preserved on all Drop Head Coupes, XKE and "E" Type Roadster Tops, when Stayfast material is ordered.

YEAR	CAR IDENTIFICATION		US Dollars	Stock Number	Approx Installation Time
JAGUAR					
1949-50	XK 120 Roadster (29" Center Deck) <i>Note: Has a shorter center deck than Ja 1670</i>	St01, St11	\$ 900.00	JA 1300	8.0
1950-57	XK 120, XK 140 Coupe <i>Note: padded top, headliner and Crank up side glass windows</i>	St01, St11	\$ 1000.00	JA 1739	8.0
1952-54	XK 120 Roadster (33" Center Deck) <i>Note: Iron bows, no padding and no zipper on blank rear curtain.</i>	St01, St11	\$ 900.00	JA 1670	8.0
1952-54	XK 120 (Classic Top Description, Above) <i>Some frames have two holes in the rear bow for fasteners for a fold up window assembly. Use Ja1683 classic pattern for this application</i>	St01, St11	\$ 1040.00	JA 1673	8.0
1955-57	XK 120, XK 140 Roadster (Iron Bows) <i>Note: Has vinyl window horseshoe zipper included</i>	St01, St11	\$ 1000.00	JA 1680	8.0
1955-57	XK 120, XK 140 (Classic Top Description, Above) <i>Double blank window Note: Hand-folded edges.</i>	St01, St11	\$ 1200.00	JA 1683	8.0
1958-61	XK150 Drophead Coupe (Padded Top) <i>Note: Zipper window</i>	St01, St11	\$ 900.00	JA 2339	8.0
1958-61	XK 150 Roadster <i>Note: Horseshoe zipper included</i>	St01, St11	\$ 900.00	JA 2599	8.0

* Pricing below is for tops only not accessories *

Materials Other than Listed Above or Below, Please Call for Availability and Prices.

Add
To ST11 For ST Colors
Not Listed \$ 100.00

YEAR	CAR IDENTIFICATION		US Dollars	Stock Number	Approx Installation Time
	Jaguar				
1961-71	XKE Roadster	IB11	\$ 462.00	JA 6240	5.0
		St11	\$ 758.00		
	Zipper Option		\$ 96.00		
	Note: Six cylinder engine				
1971-74	XKE Roadster V-12	IB11	\$ 519.00	JA 6900	5.0
		St11	\$ 815.00		
	Note: Velcro on 1/4 flaps				
1986-88	XJ-S (Hess & Eisenhardt)	Tr01	\$ 475.00	JA 7520	8.0
		St11	\$ 815.00		
	Glass window (Reusing Glass - Call for Details)		\$ 360.00	ET 7520	3.0
	Glass window (Original Glass - Call for Details)		\$ 636.00	ET 7521	3.0
	Note: Factory Conversion				
1986-88	XJ-S Targa (Rear Half with Window)	Sg01, Sg11	\$ 1400.00	JA 7190	10.0
		Gr11	\$ 1600.00		
	Note: 1.5 yds of the same material will be needed to cover front half. Can be order separately				
1989-96	XJ-S V-12 (Glass Window Must Be Reused)	Sg01, Sg11	\$ 780.00	JA 7560	8.0
		Gr11	\$ 920.00		
	Headliner Available (Tan & Grey Velour Only)		\$ 385.00		
	Rear Belt Cable (See Cable Pages) WE DO NOT WARRANTEE		\$ 102.00		
	Note: Glass Window Must Be Reused				
1997-06	XK8, XKR Convertible (Glass Window Must Be Reused)	Sg11	\$ 780.00	JA 7730	8.0
		Gr11	\$ 920.00		
	Headliner 1997-2000 Tan Only (Not Original)		\$ 542.00		4.0
	Headliner 2001-04 Tan Only (Not Original)		\$ 542.00		4.0
	Note: Glass Window Must Be Reused				
	Original Material 1999-00 Twillfast				
	2002-10 Sonnenland				
2007-12	XK, XKR Convertible (Glass Window)	Sg11	\$ 1400.00	JA 7860	8.0
		Gr11	\$ 1600.00		
	Sewn in Padding and Plastic Retainers				
	Original Material 2007-10 Sonnenland				



JA 7860 TOP

**Compliments of
Teds Auto Trim
Naples FL
JA 7860 Top**

* Labor times are based on when the cars were new *

Materials Other than Listed Above or Below, Please Call for Availability and Prices.

Add For Pinpoint OE Colors Black Lining \$ 44.00	*Add* For Pinpoint OE Colors Tan Lining \$ 100.00	*Add* To ST11 For ST Colors Not Listed \$ 100.00	*Add* To SG or GR For Colors Other Than Listed Above \$ 100.00
--	---	--	--



Electron Top

YEAR	CAR IDENTIFICATION	List Price TR01 or TR02	Stock Number	Approx Installation Time
		US Dollars		
JENSEN HEALEY				
1972-75	Roadster	\$ 600.00	JN 6920	3.0
1974-76	Interceptor III Note: Zipper Window Headliner is Not Supplied	\$ 1000.00	JN 7129	16.0
KARMANN GHIA				
1958-59	Coupe Note: Original Top Tacks Across Front Bow Tacks are Covered With a Chrome Molding Headliner Available in Perforated Vinyl, (Off white only) Front Header Bow Rear Top Bow Rear Base Bow Universal Cables	\$ 500.00 \$ 254.00 \$ 772.00 \$ 348.00 \$ 630.00 \$ 24.00	VW 6130	6.5
1960-60	Coupe Note: Original Top is Bound Across Front Bow. Tacked Underneath, 28" Wide Stitched in Rear Window Headliner Available in Perforated Vinyl, (Off white only) Front Header Bow Rear Top Bow Rear Base Bow Universal Cables	\$ 500.00 \$ 254.00 \$ 772.00 \$ 348.00 \$ 630.00 \$ 24.00	VW 6450	6.5 Bow Height Might be 22" (Call)
1960-63	Coupe Note: Original Top is Bound Across Front Bow Rear Curtain is Separate from Top Headliner Available in Perforated Vinyl, (Off white only) Front Header Bow Rear Top Bow Rear Base Bow Universal Cables	\$ 500.00 included \$ 254.00 \$ 772.00 \$ 348.00 \$ 630.00 \$ 24.00	VW 6020	6.5 Bow Height Might be 22" (Call)
1961-67	Coupe Note: Original top is bound across front bow and has a sewn in rear window included Headliner Available in Perforated Vinyl, (white only) Front Header Bow Rear Top Bow Rear Base Bow Universal Cables Top Pad (Pad Bag and Foam)	\$ 520.00 \$ 254.00 \$ 772.00 \$ 348.00 \$ 630.00 \$ 24.00 \$ 426.00	VW 6470	6.5

* Pricing below is for tops only not accessories *

Materials Other than Listed Above or Below, Please Call for Availability and Prices.

Add
For Pinpoint OE Colors
Black Lining \$ 44.00

Add
For Pinpoint OE Colors
Tan Lining \$ 100.00

Add
For Stayfast or Topline
ST11 and ST14 Only \$ 340.00

Add
For Stayfast or Topline ST Colors
and/or with Tan Lining \$ 440.00

YEAR	CAR IDENTIFICATION	List Price TR01 or TR02	Stock Number	Approx Installation Time
	Karmann Ghia	US Dollars		
1967-69	Coupe (Early 69) Headliner Available in Perforated Vinyl Front Header Bow Rear Top Bow Universal Cables Rear Belt Cable Top Pad (Pad bag and foam) Rear Base Body Bow (Up to Mid 1969) Note: No tacking on rear bow and has a vinyl rear window Note: Tan Leatherette around window regardless of lining color of top.	\$ 540.00 \$ 305.00 \$ 772.00 \$ 348.00 \$ 24.00 \$ 48.00 \$ 486.00 \$ 630.00	VW 6810	6.0
1969-76	Coupe Headliner Available in Crush or Perforated Vinyl Front Header Bow Rear Top Bow Universal Cables Rear Belt Cable Rear Window Cable Top Pad (Pad bag and foam) Note: Glass rear window model comes with rubber ring sewn on Note: Black Leatherette around window regardless of lining color of top.	\$ 580.00 \$ 305.00 \$ 772.00 \$ 348.00 \$ 24.00 \$ 48.00 \$ 48.00 \$ 486.00	VW 6850	6.0
	LANCIA			
1956-??	Lancia	\$ 795.00	LA 6340	
1960-??	Appia	\$ 795.00	LA 6190	
1962-??	Flaminia Note: 6 Tenax Fasteners Not supplied (Can Reuse Old Ones)	\$ 795.00 \$ 12.00 ea	LA 6420	
1964-67	Appia Note: 4 Durable Fasteners on the side quarters	\$ 795.00	LA 6590	
1979-81	Zagato Hand-Rolled Binding	\$ 500.00 \$ 90.00	LA 7150	4.0

* Labor times are based on when the cars were new *

Materials Other than Listed Above or Below, Please Call for Availability and Prices.

Add
 For Pinpoint OE Colors
 Black Lining \$ 44.00

Add
 For Pinpoint OE Colors
 Tan Lining \$ 100.00

Add
 For Stayfast or Topline
 ST11 and ST14 Only \$ 340.00

Add
 For Stayfast or Topline ST Colors
 and/or with Tan Lining \$ 440.00



YEAR	CAR IDENTIFICATION	US Dollars	Stock Number	Approx Installation Time
	MASERATI			
	Also See Chrysler Page 31			
1972-??	Ghibli Note: Identification differs on earlier models	\$ 800.00	MA 7280	
1986-96	Bi Turbo (Check color of headliner) St11 Note: Lining on rear window made with tan or grey velour	\$ 980.00	MA 7650	6.5
1987-91	Chrysler Maserati (Specify Headliner Color (Tan or Black)) Vinyl Curtain (Color Matched) Glass Window (Customer Supplies Glass) (Call for Details) Glass Window (Electron Top Supplies Glass) Note: We recommend installing brackets using a 2 part urethane. Brackets can be installed with a 2 part epoxy or 3M Adhesive. Please Allow 4-5 Working Days for manufacturing.	\$ 540.00 St11 \$ 880.00 \$ 250.00 \$ 340.00 \$ 460.00	CH 4960 ET 4960 ET 4961	8.0
2003-05	Spyder GT	Call		
	MAZDA			
1989-05	MX-5 Miata Roadster (Economy Top) Pe29, Pe36, Pe40 (Vinyl Window 1 Piece Top) Window sewn in Side Cables (See Cable Pages) Note: Special Straps Included for 1989-98 Rain Rail (Fits 1989-2005 Produced Inhouse-Skim Coated Fabric)	\$ 420.00 \$ 70.00 \$ 120.00	MZ 8340	5.0
1989-98	MX-5 Miata Roadster (Original Style Top) Pe29, Pe36, Pe40 Zipper Window included Side Cables (See Cable Pages) Rain Rail (Fits 1989-2005 Produced Inhouse-Skim Coated Fabric)	\$ 680.00 \$ 70.00 \$ 120.00	MZ 8350	5.0
1989-98	MX-5 Miata Roadster (Vinyl Curtain Only) Pe29, Pe36, Pe40 Rain Rail (Fits 1989-2005 Produced Inhouse-Skim Coated Fabric) Note: Zipper can be removed from old curtain if in good shape or take top completely off and use zipper supplied with curtain.	\$ 380.00 \$ 120.00	MZ 8359v	5.0
1989-98	MX-5 Miata Roadster (Non Original Conversion Top with Zipper) Tinted Only Glass Window Pe29, Pe36, Pe40 Tinted with Defroster Glass Window Pe29, Pe36, Pe40 Dash Board Switch Glass Window Wiring Harness Side Cables (See Cable Pages) Rain Rail (Fits 1989-2005 Produced Inhouse-Skim Coated Fabric) Note: Please Allow 4-5 Working Days for Manufacturing *WARNING: Must Unzip Window Prior To Putting Top Down*	\$ 860.00 \$ 905.00 \$ 265.00 \$ 280.00 \$ 70.00 \$ 120.00	MZ 8370	5.0

* Pricing below is for tops only not accessories *

Materials Other than Listed Above or Below, Please Call for Availability and Prices.

Add To PE For PE
rorr OE Colors Not Listed
Black Lining \$ 44.00*Add* To PE
for OE Colors with
Tan Lining \$ 100.00*Add*
For Stayfast or Topline
ST11 and ST14 Only \$ 240.00*Add*
For Stayfast or Topline ST Colors
and/or with Tan Lining \$ 340.00

YEAR	CAR IDENTIFICATION	US Dollars	Stock Number	Approx Installation Time
	Mazda			
1999-05 1989-98	MX-5 Miata Roadster (No Zipper) (Conversion Top - Not original for these years) Tinted Only Glass Window Tinted with Defroster Glass Window Dash Board Switch Glass Window Wiring Harness Side Cables (See Cable Pages) (Fits 1999 to 2005 Only) Rain Rail (Fits 1999-2005 Produced Inhouse-Skim Coated Fabric) Note: Special Straps Included for 1989-98 Note: Please Allow 4-5 Working Days for Manufacturing	Pe29, Pe40 \$ 800.00 Pe29, Pe40 \$ 835.00 \$ 265.00 \$ 280.00 \$ 70.00 \$ 120.00	MZ 8380	5.5 Bow Hgt 21 3/4"
1989-05	MX-5 Miata Roadster (No Zipper) (One Piece Deck) Tinted Only Glass Window Tinted with Defroster Glass Window Dash Board Switch Glass Window Wiring Harness Side Cables (See Cable Pages) (Fits 1999 to 2005 Only) Rain Rail (Fits 1999-2005 Produced Inhouse-Skim Coated Fabric) Note: Special Straps Included for 1990-98 Note: Please Allow 4-5 Working Days for Manufacturing Original Material 2003-05 Stayfast	Call Request Request \$ 265.00 \$ 280.00 \$ 70.00 \$ 120.00		5.5 Bow Hgt 21 3/4"
2006-11	MX-5 Miata Roadster (No Zipper, 1 Pc Deck, Top & Glass, like Original) Tinted with Defroster Glass Window Side Cables (See Cable Pages) No Rubber Ring Rain Rail Note: Please Allow 4-5 Working Days for Manufacturing Original Material 2006-10 Stayfast	Pe29, Pe40 \$ 860.00 St11, St45 \$ 1100.00 \$ 84.00 \$ Call	MZ 8400	7.0 Bow Hgt 21 3/4"



2002 MAZDA

*Compliments of
Kenny McCombs
Convertible Top Man, GA.
MZ 8380 Top*

* Labor times are based on when the cars were new *

Materials Other than Listed Above or Below, Please Call for Availability and Prices.

**Add* To PE For PE or OE Colors Not Listed Black Lining \$ 44.00*

**Add* To PE for OE Colors with Tan Lining \$ 100.00*

**Add* To ST11 For ST Colors Not Listed \$ 100.00*

**Add* To ST11 For ST Colors with Tan Lining \$ 200.00*



YEAR	CAR IDENTIFICATION		US Dollars	Stock Number	Approx Installation Time
MERCEDES					
1951-58	300 S Roadster <i>Note:</i> No Landau bars, headliner or padded roof; top folds flat	Gr01, Gr04	\$ 1160.00	ME 6010	
1951-55	220 Cabriolet A <i>Note:</i> Has padded roof and Landau bars	Gr01, Gr04	\$ 1130.00	ME 6440	
1951-56	300, 300 B, 300 C, (4 Door) <i>Note:</i> Padded roof	Gr01, Gr04	\$ 1160.00	ME 6460	
1951-58	300 S Cabriolet (2 Door) <i>Note:</i> Has padded roof and Landau bars	Gr01, Gr04	\$ 1160.00	ME 6550	
1951-53	220 Cabriolet B (2 Door) <i>Note:</i> Has full rear seat, quarter windows, padded roof and Landau bar	Gr01, Gr04	\$ 1220.00	ME 6860	
1956-63	190 SL <i>Note:</i> Stainless steel cable is sewn in like original	Gr01, Gr04	\$ 1000.00	ME 2400	5.5
1958-63	300 SL <i>Note:</i> Top is made like the original with sleeves for the center deck cables and a 1/2 yard of lining material included	Gr01, Gr04	\$ 1200.00	ME 6110	8.0
1956-60	220 S, 220 SE (2 Door) 20 1/2" Bow Height <i>Note:</i> Padded roof with zipper window	Gr01, Gr04	\$ 1320.00	ME 6129	7.5



* Pricing below is for tops only not accessories *

Materials Other than Listed Above or Below, Please Call for Availability and Prices.

Add
To GR01 For GR Colors
Not Listed \$ 100.00

Use GR01 Price
For All SG and ST Colors
Not Listed

"Our Reputation is Tops!"

MERCEDSES

YEAR	CAR IDENTIFICATION		US Dollars	Stock Number	Approx Installation Time
	Mercedes				
1958-63	300 D (4 Door) Note: Padded roof with zipper window	Gr01, Gr04	\$ 1480.00	ME 6149	9.0
1964-71	230, 250, 280 SL's Roadster Side Window Rubbers included Some early 1964 cars had a chrome molding across rear bow Note: One window and no piping	Gr01, Gr04 SG01, SG04	\$ 900.00 \$ 800.00	ME 6780	6.0
1960-71	220 SEB, 250, 280, 300 SE's Note: Padded roof, top installs to trim stick at rear body	Gr01, Gr04	\$ 1220.00	ME 7050	8.0
1972-89	280, 350, 380, 450, 500, 560 SL's Roadster Note: Three windows with piping Side Window Rubbers included Original Material 1972-89 Sonnenland	Gr01, Gr02, Gr03 SG01, SG02, SG03	\$ 900.00 \$ 800.00	ME 7290	8.0

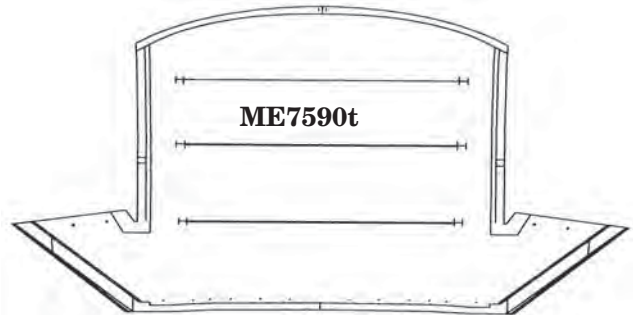
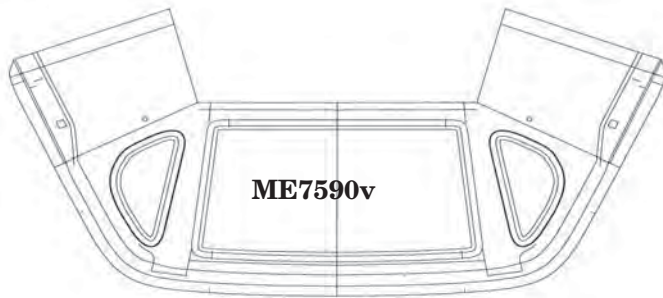

1990-03	300, 320, 500, 600 SL's Roadster Headliner Available Beige Headliner Available Beige or Grey Brocade Rear Bow Gasket Note: See picture above	Gr01 or Gr11 Top Only Sg01 or Sg11 Top Only	\$ 580.00 \$ 480.00 \$ 430.00 \$ 556.00 \$ 140.00	ME7590t	5.0 SG 3.0
1990-03	300, 320, 500, 600 SL's Roadster Order ME 7590t and ME 7590v Together Note: Discount Only on Sonnenland Original Material 1990-03 Sonnenland	Gr01 or Gr11 Vinyl Curtain Sg01 or Sg11 Top Only Gr01 or Gr11 Top & Curtain Together	\$ 660.00 \$ 560.00 \$ 1140.00	ME7590v	8.0 10.0

Warranty: WE cannot warranty our vinyl rear windows on 1990-on Mercedes convertible tops. This information has been based on service bulletins provided by Mercedes number 77/26A and 77/39. These bulletins describe abrasions, cuts, tears, holes, pinching and other damages due to the topping and seams in the front section of the top and the rear window assembly. In addition; other damages include; fraying, creasing and breaking of the vinyl rear window caused by the top frame and body assembly of this vehicle. It is never our intent to avoid responsibility, but WE cannot be held accountable for poor design by an original equipment manufacturer.

Materials Other than Listed Above or Below, Please Call for Availability and Prices.

Add
To GR01 For GR Colors
Not Listed \$ 100.00

Use GR01 Price
For All SG and ST Colors
Not Listed



YEAR	CAR IDENTIFICATION		US Dollars	Stock Number	Approx Installation Time
Mercedes					
1992-95	E 320, CE (Full Size Glass Rear Window) Headliner Available Beige or Grey Twill (1993-94) Headliner Available Beige or Grey Brocade (1995) Note: Please Reuse Glass Window	Gr11	\$ 1000.00 \$ 765.00 \$ 974.00	ME 7670	14.0
1999-03	CLK, 320 & 420 (Stitched Reinforcement) French Binding when needed. Raw Glass Piece (Glass Only No Rubber Trim) Gasket Kit for Rear Window Part # 602-15FC-100 Note: Metal Frame Must Be Reused Glass Window Can Be Reused Original Material 1999-03 Sonnenland	Gr11	\$ 1190.00 \$ 160.00 \$ 280.00 \$ 35.00	ME 7810 PP 7810	14.0
2004-09	CLK (Stitched Reinforcement) Raw Glass Piece (Glass Only No Rubber Trim) Note: Metal Frame Must Be Reused Glass Window Can Be Reused Original Material 2004-08 Sonnenland	Gr11	\$ Call	ME 7880	
MG					
1946-49	TC		<i>List Price</i> <i>TR01 or IB11</i> \$ 490.00	MG 1200	5.0
		St11	\$ 830.00		
1950-53	TD (2 Bow) Note: Front bow plus 2 iron bows		\$ 490.00	MG 1210	5.0
		St11	\$ 830.00		
1952-53	TD (3 Bow) Note: Front bow plus 3 iron bows		\$ 490.00	MG 1330	5.0
		St11	\$ 830.00		
1954-55	TF, TF 1500		\$ 490.00	MG 1450	5.0
		St11	\$ 830.00		
1946-55	MG 1210, MG 1330, MG 1450 (Side Curtains) Note: Wires are not installed in lower edge of door curtain. WE leave the lower edge not bound or sewn for the insertion of the original wire and the binding is left long to complete the edge.		\$ 490.00		
		St11	\$ 830.00		
1956-58	MGA Note: 3 Windows		\$ 490.00	MG 2270	4.0
		St11	\$ 830.00		

* Pricing below is for tops only not accessories *

Materials Other than Listed Above or Below, Please Call for Availability and Prices.

Add
For Pinpoint OE Colors
Black Lining \$ 44.00

Add
For Pinpoint OE Colors
Tan Lining \$ 100.00

Add
To ST11 For ST Colors
Not Listed \$ 100.00

Add
To GR11 for Gr Colors
Not Listed \$ 100.00

YEAR	CAR IDENTIFICATION	List Price TR01 or IB11	Stock Number	Approx Installation Time
	MG	US Dollars		
1959-59	MGA (No bow sleeves) Note: 3 Windows	\$ 490.00	MG 2670	4.0
1960-62	MGA 1600 Mark II Note: 3 Windows	\$ 490.00	MG 6350	4.0
1963-70	MGB Removable Frame	\$ 490.00	MG 6520	4.0
1964-67	MGB Folding Frame TYPE I	\$ 490.00	MG 7010	4.0
1964-69	MGB Folding Frame TYPE II Note: 19 1/4" seam at rear bow to seam below vinyl window	\$ 490.00	MG 7030	4.0
1970-76	MGB Folding Frame TYPE III Note: 20 1/4" seam at rear bow to seam below vinyl window	\$ 475.00	MG 7240	4.0
1977-80	MGB Folding Frame TYPE III Note: Zipper window Note: Can be use on earlier car	\$ 490.00	MG 7249	4.0
1961-64	Midget MK II Note: Top has Front Strip and Rear Bar	\$ 550.00	AU 6310	4.0
1964-67	Midget MK III Note: Top has Rear Bar	\$ 500.00	AU 7020	4.0
1967-79	Midget MK IV, 1500 Note: Needs 6 Tenax Sockets and Plates (Can reuse old ones)	\$ 500.00 \$ 12.00 ea	AU 7090	4.0

MERCEDDES
MG

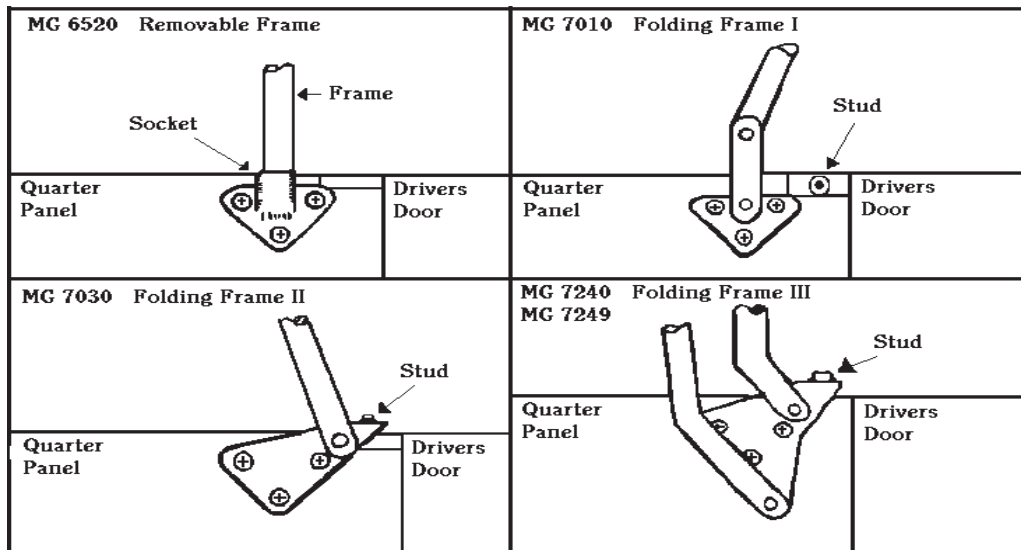

* Labor times are based on when the cars were new *

Materials Other than Listed Above or Below, Please Call for Availability and Prices.

Add
For Pinpoint OE Colors
Black Lining \$ 44.00

Add
For Pinpoint OE Colors
Tan Lining \$ 100.00

Add
For Stayfast or Topline
ST11 and ST14 Only \$ 340.00

Add
For Stayfast or Topline ST Colors
and/or with Tan Lining \$ 440.00



YEAR	CAR IDENTIFICATION		US Dollars	Stock Number	Approx Installation Time
MINI COOPER					
2004-08	Mini & Mini Cooper S Heated glass window is part of top.	Sg11	\$ 1400.00	MC 8570	7.0
2009-13	Mini & Mini Cooper S Heated glass window is part of top. Note: We need plastic extrusions from quarters to make this top. Core Charge: (If We Send Top Before Getting Extrusions) When Available	Sg11	\$ 1400.00 \$ 700.00	MC 8580	7.0
MITSUBISHI					
1996-99	Eclipse Spyder Glass Window Tinted with Defroster Headliner Available Black Front Webbing Pad Set 6" x 55" Standard Rear Webbing Pad Set 6" x 30" Side Cables (See Cable Pages) Suggested Color ST11 ST14 Original Material 1996-99 Stayfast Note: See Manufacturers TSB'S on our Website	St11, St14	\$ 850.00 included \$ 356.00 \$ 34.00 \$ 18.00 \$ 58.00	MI 5200	6.0 Bow Hgt 22 3/4"
2000-05	Eclipse Spyder Glass Window Tinted with Defroster Headliner Available Black Front Webbing Pad Set 6" x 55" Standard Rear Webbing Pad Set 6" x 30" Side Cables (See Cable Pages) Suggested Color ST11 ST14 Original Material 2000-05 Stayfast Note: See Manufacturers TSB'S on our Website	St11, St14	\$ 860.00 included \$ 356.00 \$ 34.00 \$ 18.00 \$ 60.00	MI 5220	6.0 Bow Hgt 22 3/4"
2006-12	Eclipse Spyder Glass Window Tinted with Defroster Headliner Available Black Front Webbing Pad Set 6" x 55" Standard Rear Webbing Pad Set 6" x 30" Side Cables (See Cable Pages) Suggested Color ST11 ST42 Original Material 2006-10 Stayfast Note: See Manufacturers TSB'S on our Website	St11, St42	\$ 980.00 included \$ 472.00 \$ 34.00 \$ 18.00 \$ 135.00	MI 5240	5.5 Bow Hgt 22 3/4"



**Compliments of
Kenny McCombs
Convertible Top Man
Snellville, GA.**

* Pricing below is for tops only not accessories *

Materials Other than Listed Above or Below, Please Call for Availability and Prices.

Add
To ST for ST Colors
Not Listed \$ 100.00

Add
To SG11 For SG Colors
Not Listed \$ 100.00

"Our Reputation is Tops!"

YEAR	CAR IDENTIFICATION	List Price TR01	Stock Number	Approx Installation Time
	MORRIS MINOR	US Dollars		
1954-57	1000 Note: Front bow plus three iron bows	\$ 600.00	MO 2420	3.0
1957-62	1000 Note: Front bow plus four iron bows	\$ 600.00	MO 2430	3.0
	NASH METROPOLITAN			
1954-61	Metropolitan Vinyl Curtain is part of top	\$ 500.00	NA 1570	Bow Hgt 19 1/4"
	NISSAN			
1992-94	240 SX Vinyl Curtain (Color Matched) Headliner Available in Black Side Cable (See Cable Pages) Original Material 1992-94 Stayfast	St11 \$ 740.00 \$ 200.00 \$ 360.00 \$ 60.00	NS 5350	6.0 3.0 Bow Hgt 24 3/4
1993-96	300 ZX (Three Windows) Headliner Available in Black Side Cable (See Cable Pages) Original Material 1993-94 Stayfast 1995-96 Pinpoint Vinyl	St11 \$ 700.00 \$ 360.00 \$ 60.00	NS 5400	6.0
2003-09	350 Z (Glass Window Tinted With Defroster) Side Cables (See Cable Pages) Note: Please Allow 4-5 Working Days for Manufacturing Warning: Window Regulators must work or the glass will not go down and this will result in the glass rubbing against the binding. Elastic straps must be replaced or top will not fold. Note: See Manufacturers TSB'S on our Website Original Material 2004-09 Twill Vinyl	Ht01, Ht03 St11 \$ 980.00 \$ 1220.00 \$ 135.00	NS 5410	8.0
2010-13	370 Z (Glass Window Built into Top)	Ht01, Ht03 St11 Call Call	NS 5430	
2010-13	Murano (Glass Windows Built into Top)			

* Labor times are based on when the cars were new *

Materials Other than Listed Above or Below, Please Call for Availability and Prices.

**Add* To Ht01
For OE Colors
Black Lining \$ 44.00*

**Add* To Ht01
For OE Colors with
Tan Lining \$ 100.00*

**Add*
To HT01 For PE Colors
Not Listed \$ 44.00*

**Add*
To ST11 For ST Colors
Not Listed \$ 100.00*

MINI COOPER
MITSUBISHI
MORRIS
NASH
NISSAN



Electron Top

YEAR	CAR IDENTIFICATION	List Price TR01 or TR02	Stock Number	Approx Installation Time
		US Dollars		
	OPEL			
1955-56	All Models	Request	OP 5990	
	PEUGEOT			
1960-63	Peugeot Separate Curtain and No Quarter Windows	Request	PE 6540	
1964-66	Peugeot Horseshoe Zipper Vinyl Window	Request	PE 6750	
1967-75	Peugeot 204, 304 Removable Wrap-around Window and has Velcro on Quarters	\$ 674.00	PE 6889	6.0
1968-83	Peugeot 504 Wire Sleeve Across Front Bow Sewn in Rear Window	\$ 768.00	PE 6890	8.0
	PORSCHE			
1954-56	356 Speedster 13" Bow Height Note: 13" Rear curtain height (Measured from binding to seam at center)	Gr01, Gr11 \$ 1090.00	PO 2550	5.0
1955-56	356 Speedster 15" Bow Height Note: 15" Rear curtain height (Measured from binding to seam at center)	Gr01, Gr11 \$ 1090.00	PO 2520	5.0
1955-56	Cabriolet 1300, 1600 Note: (V) Windshield and headliner	Gr01, Gr11 \$ 1090.00	PO 2540	4.0
1957-59	Convertible D (Roll Up Windows) Note: Top has pads, but no headline	Gr01, Gr11 \$ 1090.00	PO 2560	4.0
1959-62	356 1600 Roadster Note: Top has pads, but no headliner	Gr01, Gr11 \$ 1000.00	PO 2830	4.0
1959-62	Cabriolet Note: Padded top and headliner	Gr01, Gr11 \$ 1000.00	PO 6250	4.0
1962-67	Cabriolet Note: Zipper window and headliner	Gr01, Gr11 \$ 1090.00	PO 6609	4.0

* Pricing below is for tops only not accessories *

Materials Other than Listed Above or Below, Please Call for Availability and Prices.

Add
For Pinpoint OE Colors
Black Lining \$ 44.00

Add
For Pinpoint OE Colors
Tan Lining \$ 100.00

Add
To GR01 For GR Colors
Not Listed \$ 100.00

Use GR11 Price
For All SG and ST Colors
Not Listed

YEAR	CAR IDENTIFICATION		US Dollars	Stock Number	Approx Installation Time
Porsche					
1968-83	Targa Note: Made in Blk/Blk concord crush grain material	Cn04	\$ 640.00	PO 6689	5.0
		Curtain only			
1968-94	Targa (30 1/2" Front to Back Measurement, Center of Top) Note: For originality, this top should be ordered Top only in Blk/Blk Levant if the rear window is glass and Blk/Blk Crush if the rear window is vinyl.	CN04	\$ 180.00	PO 7260	4.0
1968-94	Targa (One Side Unfinished, 31 1/2" Measurement, Part Included) Note: For originality, this top should be ordered Top only in B/B Levant if the rear window is glass and Blk/Blk Crush if the rear window is vinyl.	Cn04	\$ 160.00	PO 7261	4.0
1983-85	Carrera, 911 SC (Top Only) Headliner Available in Black Herringbone Spl Webbing Elastic Straps (1" X 22") Note: Top does not have a rain rail above door window	Gr11 Sg11	\$ 500.00 \$ 400.00 \$ 54.00 \$ 60.00	PO 7380t	4.0
1983-84	Carrera, 911 SC (Curtain Only) Note: Large window (51" x 19")	Gr11 Sg11	\$ 600.00 \$ 500.00	PO7389v	8.0
1983-94	Carrera, 911 SC (Top Only) Headliner Available in Black Herringbone Spl Webbing Elastic Straps (1" X 22") Note: Top has a rain rail above door glass	Gr11 Sg11	\$ 500.00 \$ 400.00 \$ 54.00 \$ 60.00	PO7500t	4.0
1983-94	Carrera, 911 SC (Curtain Only) Note: Small window (41 1/2" x 19")	Gr11 Sg11	\$ 600.00 \$ 500.00	PO7509v	8.0



**Compliments of
Kenny McCombs
Convertible Top Man,
Snellville, GA.**

* Labor times are based on when the cars were new *

Materials Other than Listed Above or Below, Please Call for Availability and Prices.

***Subtract * \$ 100.00 From
GR or SG When Ordering
Top and Curtain Together**

***Add*
To GR11 For GR Colors
Not Listed \$ 100.00**

***Use GR11 Price*
For All SG and ST Colors
Not Listed**



YEAR	CAR IDENTIFICATION		US Dollars	Stock Number	Approx Installation Time
Porsche					
1989-94	Cabriolet 944, 968 Cabriolet (Top Only)	Gr11	\$ 540.00	PO 7550t	5.0
1989-94	Cabriolet 944, 968 Cabriolet (Clear Vinyl Window Only)	Gr11	\$ 690.00	PO 7550v	8.0
1995-98	993 - 911 Carrera Cabriolet (Sewn in Green Plastic Window) Tinted Plastic Window with Zipper for Headliner Installation	Gr11	Call	PO 7850	9.0
1997-02	Boxster - 986 (Plastic Window) Green Vinyl Window (Width 36") included Original Material 1997-02 Sonnenland	Gr11, Gr13	\$ 920.00	PO 7760	9.0
1997-02	Boxster - 986 (Upgrade Heated Glass Window) Wire Harness for Glass Note: Please Allow 4-5 Working Days for Manufacturing Warning: Engine Compartment will not Fully Open with Glass Conversion Top.	Gr11, Gr13	\$ 1160.00 \$ 76.00	PO 7790	9.0
1999-01	996 - 911 Carrera Cabriolet (Sewn in Green Plastic Window) Tinted Plastic Window with Zipper for Headliner Installation	Gr11	Call	PO 7740	9.0
2002-08	996, 997 - 911 Carrera 4 Turbo S Cabrio Note: (Reuse your Existing Glass Window)	Gr11	Call	PO 7970	9.0
2003-04	Boxster - 986 (Heated Glass Window) Original Material 2002-04 Sonnenland	Gr11, Gr13	Call		
2005-On	Boxster - 987 (Heated Glass Window) Original Material 2005-on Sonnenland	Gr11	Call		



Compliments of
 Kenny McCombs
 Convertible Top Man,
 Snellville, GA.

* Pricing below is for tops only not accessories *

Materials Other than Listed Above or Below, Please Call for Availability and Prices.

**Subtract * \$ 100.00 From
GR or SG When Ordering
Top and Curtain Together*

**Add*
To GR11 For GR Colors
Not Listed \$ 100.00*

**Use GR11 Price*
For All SG and ST Colors
Not Listed*

YEAR	CAR IDENTIFICATION	List Price TR01 or TR02	Stock Number	Approx Installation Time
	RAGTIME MINI	US Dollars		
1979-83	Toyota Pickup	\$ 720.00	RT 1025	2.0
1972-78	Toyota Pickup	\$ 720.00	RT 1050	2.0
1980-81	Datsun Pickup	\$ 720.00	RT 1080	2.0
1979-83	Ford Courier, Mazda Pickup	\$ 720.00	RT 3475	2.0
1973-79	Datsun Pickup	\$ 720.00	RT 3500	2.0
1979-83	Chevy Pickup	\$ 720.00	RT 5500	2.0
1979-83	Dodge Pickup	\$ 720.00	RT 9250	2.0
	RENAULT			
	See Rambler Page 67			
1960-61	Caravelle	\$ 600.00	RE 6000	6.0
1961-63	Caravelle	\$ 600.00	RE 6180	6.0
1964-67	Caravelle	\$ 600.00	RE 6620	6.0
1984-87	AMC Alliance (Solid Color Top) Vinyl Curtain (Color matched) Standard Universal Pad Set 66" Suggested Color TR01 TR02	\$ 380.00 \$ 196.00 \$ 70.00	RE 7440	6.0 3.0 Bow Hgt 22 3/4"
1984-87	AMC Alliance (Two Tone Style Top) (See Picture Below) Vinyl Curtain (Color matched) Standard Universal Pad Set 66" Suggested Color TR01 TR02	\$ 440.00 \$ 196.00 \$ 70.00	RE 7441	6.0 3.0

RAGTIME

RENAULT

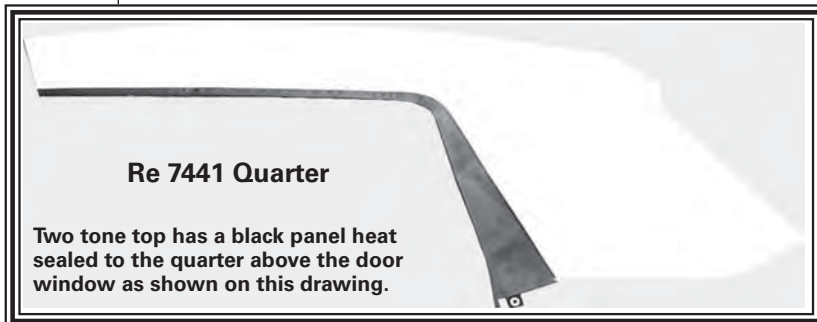

* Labor times are based on when the cars were new *

Materials Other than Listed Above or Below, Please Call for Availability and Prices.

Add
for Oe01 or Oe02
Black Lining \$ 44.00

**Add* for Oe or Sa*
Materials Not Listed Above
and/or W/Tan Lining \$ 100.00

Add
For Stayfast or Topline
St11 and St14 Only \$ 340.00

Add
For Stayfast or Topline (St) Colors
other than St11 and St14 \$ 410.00



YEAR	CAR IDENTIFICATION		US Dollars	Stock Number	Approx Installation Time
	ROLLS ROYCE				
1972-91	Corniche Vinyl Curtain Lined with Wool Broadcloth, Please Specify Color (Tan or Grey) Note: Customer must supply one yard of matching headlining material that is needed for the rear curtain.	Br01	\$ 1430.00 included	RR 7330	16.0 Bow Hgt 23 1/2"
	SAAB				
1986-94	900 Turbo (Available with Vinyl or Cloth Binding) Glass Curtain Tinted Only Glass Curtain Tinted with Defroster Glass Curtain Tinted Only Glass Curtain Tinted with Defroster Vinyl Curtain (Color matched) Headliner Available in Black Side Cables (See Cable Pages) 9" Webbing Pads 60" Long (See Pad Pages) Spl Rear Webbing Pad Set. Note: See Bulletins Page for Manufactures TSB's	St11 Sg11 Gr11	\$ 680.00 \$ 780.00 \$ 920.00	SB 7080	6.0 Bow Hgt 23 1/2"
		Plain Lining	\$ 340.00	ET 7089t	3.0
		Plain Lining	\$ 380.00	ET 7089h	3.0
		Sonnendecke Lining	\$ 450.00	ET 7089t	3.0
		Sonnendecke Lining	\$ 490.00	ET 7089h	3.0
		Plain Lining	\$ 196.00		
			\$ 386.00		
			\$ 52.00		
			\$ 34.00		
			\$ 20.00		
1995-95	900 SE (Has binding around Rear Window) Glass Window Tinted with Defroster Headliner Available in **Black Dane** (Original Headliner Must be Other than Brocade) Side Cables (See Cables Pages) Note: Please Allow 4-5 Working Days for Manufacturing	Sg11	\$ 1230.00 included \$ 386.00 \$ 52.00	SB 7950	8.0
1996-98	900 SE (Metal Glass Frame is on the Inside of the Top) Heated Glass Raw Window Headliner (1997-1999) Available in **Black Brocade** 4" Webbing Pads 60" Long (See Pad Pages) Side Cables (See Cables Pages) Note: Our top is not top stitched	Sg11	\$ 860.00 \$ 290.00 \$ 1030.00 \$ 28.00 \$ 52.00	SB 7960 PP 7960	9.5 3.0
1998-03	Saab 9-3 (Metal Glass Frame is on the Inside of the Top) Headliner (1998-2003) Available **Grey/Taupe Foam** Standard Universal Front Pad 9" x 60" Nylon Webbing Side Cables (See Cables Pages) Heated Glass Raw Window Original Material 1999-03 Sonnenland	Sg11 Gr11	\$ 820.00 \$ 960.00 \$ 568.00 \$ 34.00 \$ 52.00 \$ 400.00	SB 7980 PP 7980	8.0 3.0



* Pricing below is for tops only not accessories *

Materials Other than Listed Above or Below, Please Call for Availability and Prices.

Add
To ST11 For ST Colors
Not Listed \$ 100.00

Add
To SG11 For SG Colors
Not Listed \$ 100.00

Add
To GR11 For GR Colors
Not Listed \$ 100.00

YEAR	CAR IDENTIFICATION	US Dollars	Stock Number	Approx Installation Time
2004-09	<div data-bbox="277 279 493 336" style="border: 1px solid black; padding: 5px; display: inline-block;">SAAB</div> <p>Saab 9-3 (Metal Glass Frame is on the Inside of the Top) St11</p> <p style="text-align: right;">Sg11, Sg13, Sg26 \$ 1040.00</p> <p style="text-align: right;">Gr11, Gr13 \$ 1140.00</p> <p style="text-align: right;">\$ 1340.00</p> <p style="text-align: right;">\$ 94.00</p> <p>Side Cables (See Cables Pages) Note: Top pad built into top. Note: Must reuse glass. Original Material 2004-10 Sonnenland</p> <div data-bbox="329 642 1058 1161" style="border: 2px solid black; padding: 10px; text-align: center;">  </div>	US Dollars	SB 7990	
2008-on	<div data-bbox="277 1199 646 1255" style="border: 1px solid black; padding: 5px; display: inline-block;">SMART CAR</div> <p>Passion or Brabus Cabriolet</p> <div data-bbox="367 1377 1000 1797" style="border: 2px solid black; padding: 10px; text-align: center;">  </div>	Call		

Compliments of
 Kenny McCombs
 Convertible Top Man,
 Snellville, GA.

* Labor times are based on when the cars were new *

Materials Other than Listed Above or Below, Please Call for Availability and Prices.

Add
 To ST11 For ST Colors
 Not Listed \$ 100.00

Add
 To SG11 For SG Colors
 Not Listed \$ 100.00

Add
 To GR11 For GR Colors
 Not Listed \$ 100.00

ROLLS

SAAB

SMART CAR



YEAR	CAR IDENTIFICATION	List Price TR01 or IB11	Stock Number	Approx Installation Time
	SUNBEAM	US Dollars		
1952-54	Talbot (Two Seater)	\$ 740.00	RO 2470	4.0
1952-55	Alpine Note: Zipper window	\$ 780.00	RO 2489	4.0
1957-62	Rapier Note: Spl Front Pad Set	\$ 780.00 \$ 94.00	RO 6089	6.0
1959-61	Alpine Series I Note: Top is identified by a bent wire hook sewn into the top at the quarter panels and also a zipper on each side that allows the top to fold. WE supply a top that used a later type retainer at the side quarters that holds the top by wedging between side wings of the hard boot and the body. It is necessary to install a glove button & stud on each side to attach the top to the main frame 1 1/4" above the body.	\$ 700.00	RO 6150	6.0
1961-63	Alpine Series II Note: This model has frame parts over the door windows that detach for the folding operation.	\$ 700.00	RO 6060	4.0
1963-66	Alpine Series III, IV Tiger Note: Wire sleeve	\$ 580.00	RO 6500	4.0
1966-68	Alpine Series IV Note: Top has velcro over the door windows and a long flap on inside 1/4 panels that fastens to the drain rail. Note: Please specify wire sleeve or velcro.	\$ 580.00	RO 6770	4.0



1960 Alpine Series I
RO 6150

* Pricing below is for tops only not accessories *

Materials Other than Listed Above or Below, Please Call for Availability and Prices.

Add
For Pinpoint OE Colors
Black Lining \$ 44.00

Add
For Pinpoint OE Colors
Tan Lining \$ 100.00

Add
For Stayfast or Topline
ST11 and ST14 Only \$ 240.00

Add
For Stayfast or Topline ST Colors
and/or with Tan Lining \$ 340.00

"Our Reputation is Tops!"

YEAR	CAR IDENTIFICATION	List Price TR01	Stock Number	Approx Installation Time
	TOYOTA	US Dollars		
1980-83	Sunchaser (Half Roof)	\$ 340.00	TY 7310	
	St11	\$ 680.00 included		
	Note: One window			
1980-83	Sunchaser (Half Roof)	\$ 340.00	TY 7410	
	St11	\$ 680.00 included		
	Note: Almost always three windows			
1984-85	Celica (Extrusion over Rear Bow)	\$ 680.00	TY 7480	6.0
	Vinyl Curtain (Color matched)	\$ 240.00		Bow Hgt 21 3/8"
	Side Cables (See Cable Pages)	\$ 52.00		
	Glass Window Tinted W/Defroster	\$ 424.00	ET 7489	3.0
	Headliner Available in Charcoal	\$ 346.00		
	Note: Glass window is 41" x 12 5/8" as found on 1985 production			
1987-90	Celica GT (Extrusion over Rear Bow)	\$ 560.00	TY 7610	6.0
	Vinyl Curtain (Color matched)	\$ 240.00		
	Front Pad 9" x 50" Nylon Webbing	\$ 28.00		
	Spl 1/4 Webbing Pads	\$ 20.00		
	Headliner Available in Charcoal	\$ 346.00		
	Side Cables (See Cables Pages)	\$ 52.00		
	Original Material 1989-90 Stayfast			
1991-93	Celica (ASC) (Bow Height 22 1/2")	\$ 460.00	TY 7680	4.0
	Vinyl Curtain (Color matched)	\$ 300.00		3.0
	Front Pad 9" x 60" Nylon Webbing	\$ 34.00		Bow Hgt 22 1/2"
	Headliner Available in Charcoal	\$ 346.00		
	Side Cables (See Cable Pages)	\$ 78.00		
	Original Material 1991-93 Stayfast			
1994-99	Celica (ASC)	\$ 560.00	TY 7710	8.0
	Vinyl Curtain (Color matched)	\$ 300.00		
	Glass Window Tinted with Defroster	\$ 440.00	ET 7710	3.0
	Headliner Available in Black	\$ 414.00		
	Side Cables (See Cable Pages)	\$ 52.00		
	Original Material 1994-99 Stayfast			
1997-99	Paseo (ASC)	\$ 360.00	TY 7720	8.0
	SA13	\$ 560.00		
	St11	\$ 300.00		
	Vinyl Curtain (Color matched)	\$ 400.00	ET 7720	3.0
	Glass Window Tinted with Defroster	\$ 70.00		
	Side Cables (See Cable Pages)			
	Original Material 1997-99 Sailcloth Vinyl			

* Labor times are based on when the cars were new *

Materials Other than Listed Above or Below, Please Call for Availability and Prices.

***Add* To TR01**
For OE or SA Colors
Black Lining \$ 44.00

***Add* To TR01**
For Pinpoint OE Colors
Tan Lining \$ 100.00

Add To St11
For ST Colors Not Listed
and/or with Tan Lining \$ 100.00



YEAR	CAR IDENTIFICATION	US Dollars	Stock Number	Approx Installation Time
	Toyota			
1997-07	MR 2 Spyder (Glass Window Tinted with Defroster)	Call	TY 7870	
2000-03	Solara (ASC) St11, St14	\$ 680.00	TY 7830	8.0
	Vinyl Curtain (Color matched)	\$ 200.00		
	Glass Window Tinted with Defroster	\$ 370.00	ET 7830	3.0
	Headliner Available in Black	\$ 358.00		
	Side Cables (See Cable Pages) (2000 thru 2003)	\$ 82.00		Bow Hgt 29"
2004-09	Solara (Glass Window Tinted with Defroster) St11, St14 (Tan Top with Tan Binding & Waterstops)	\$ 1260.00	TY 7910	7.0
2004-09	Solara (Tan Top with Black Binding & Waterstops) St14	\$ 1260.00	TY 7911	7.0
	Note: Black Water Stop Original Starting 2005	\$ 82.00		
	Side Cables (See Cable Pages) (2004 thru 2009)	\$ 485.00		2.0
	Headliner Available in Black	\$ call		
	Raingutter not like original need extra time to install			
	Note: Please Allow 4-5 Working Days for Manufacturing			
	Original Material 2004-07 Stayfast			
	2007-09 Twillfast			



TY 7910 Top
 Compliments of Kenny
 Convertible Top Man,
 Snellville, GA.

* Pricing below is for tops only not accessories *

Materials Other than Listed Above or Below, Please Call for Availability and Prices.

Add to ST11
 For ST Colors Not Listed
 and/or with Tan Lining \$ 100.00

"Our Reputation is Tops!"

YEAR	CAR IDENTIFICATION	List Price TR01 or IB11	Stock Number	Approx Installation Time
	TRIUMPH	US Dollars		
1954-55	TR 2 (Baby Tenax Fasteners Must be Reused)	\$ 550.00	TR 6090	6.0
1955-59	TR 3 Note: Needs (10) Tenax Fasteners Can reuse old ones	\$ 550.00 \$ 12.00 ea	TR 2500	6.0
1960-61	TR 3	\$ 550.00	TR 6210	6.0
1962-67	Herold (4 Passenger)	\$ 580.00	TR 6370	6.0
1961-65	TR 4 (Uses Metal Strips in Front) Note: Lift a Dot, fastens to rear deck	\$ 550.00	TR 6490	6.0
1965-67	TR 4A (Open Front)	\$ 540.00	TR 6720	5.0
1963-67	Spitfire	\$ 580.00	TR 6640	
1967-69	Spitfire MK III Note: Door glass has round corner	\$ 540.00	TR 7130	5.0
1968-69	TR 250	\$ 510.00	TR 7160	4.0
1969-76	TR 6	\$ 520.00	TR 7209	4.0
1970-??	Spitfire III (Door Glass has Round Corners) Zipper Window 26"	\$ 550.00 included	TR 7229	5.0
1971-??	Spitfire IV Zipper Window 26" Note: Rear bow seam in line with rear edge of door glass	\$ 520.00 included	TR 7279	4.0
1971-??	Stag Zipper Window in center Note: Specify one or three windows	St11 \$ 1000.00 included	TR 7309	8.0
1979-??	TR 7, TR 8 Zipper Window	\$ 620.00 included	TR 7399	4.0

* Labor times are based on when the cars were new *

Materials Other than Listed Above or Below, Please Call for Availability and Prices.

Add
For Pinpoint OE Colors
Black Lining \$ 44.00

Add
For Pinpoint OE Colors
Tan Lining \$ 100.00

Add
For Stayfast or Topline
ST11 and ST14 Only \$ 300.00

Add
For Stayfast or Topline ST Colors
and/or with Tan Lining \$ 400.00

TOYOTA
TRIUMPH



YEAR	CAR IDENTIFICATION	List Price TR01 or TR02	Stock Number	Approx Installation Time
		US Dollars		
	TVR			
1982-86	Tasmin (1/2 Roof like Toyota Sunchaser)	\$ 480.00	TV 7360	5.0
	VOLKSWAGEN			
1954-57	Standard (Molding Across Front)	\$ 380.00	VW 2020	Bow Hgt 19 1/2"
1958-59	Standard (Envelope Front)	\$ 380.00	VW 2610	Bow Hgt 21 1/2"
1960-63	Standard (Envelope Front)	\$ 380.00	VW 6200	
1963-67	Standard	\$ 380.00	VW 6530	5.5
	Headliner available in Perforated Vinyl	\$ 354.00		
	Front Header Bow	\$ 394.00		
	Rear Top Bow	\$ 346.00		
	Rear Base Body Bow	\$ 414.00		
	Quarter Wood (Check Years, inner or Outer Available)	\$ 338.00		
	Rear Wood Window Ring metal attached (Cable channel to top of ring 17")	\$ 628.00		
	Rear Rubber Window Ring (Only fits our wood ring) (Fits 1964 to 1967)	\$ 96.00		
	Plastic Window Ring (Fits 1964 to 1967)	\$ 268.00		
	Raw Glass Measurement 11 1/8" or 11 1/2"			
	Top Pad with Quarter (includes foam)	\$ 486.00		
	Universal Side Cables	\$ 24.00		
	Note: Staple Installation at Rear Body (Tacked on Rear Bow has Wireon)			
	1963 to 1967 VW			
	B = Metal to metal rear window frame to body lip of car = 3 1/2"			
	D = Lip of rear wood bow to tubular metal bow = 8 1/2"			
	E = Lip of rear wood bow to metal lip of car = 21"			
1967-72	Standard (Wood Front Bow No Wireon)	\$ 380.00	VW 6760	5.0
	Headliner available in Perforated or Crush Vinyl	\$ 354.00		
	Front Header Bow	\$ 394.00		
	Rear Top Bow	\$ 346.00		
	Quarter Wood (Check Years, inner or Outer Available)	\$ 338.00		
	Rear Base Body Bow Early (1967)	\$ 414.00		
	Rear Base Body Bow Late (67-72)	\$ 322.00		
	Rear Wood Window Ring metal attached (Fits 1967 to 1972)	\$ 628.00		
	Plastic Window Ring (Fits 1967 to 1972)	\$ 268.00		
	(Cable channel to top of ring 17")			
	Rear Rubber Window Ring (Only fits our wood ring) 1964 to 1974	\$ 96.00		
	Raw Glass Measurement 11 1/8" or 11 1/2"			
	Top Pad with Quarter (includes foam)	\$ 486.00		
	Universal Side Cables	\$ 24.00		
	Rear Belt Cable	\$ 48.00		
	Bow height 23 1/2, Measure bottom cable to top bow.			
	Note: Belt Cable Installation at Rear Body			

* Pricing below is for tops only not accessories *

Materials Other than Listed Above or Below, Please Call for Availability and Prices.

Add For Pinpoint OE Colors Black Lining \$ 44.00	*Add* For Pinpoint OE Colors Tan Lining \$ 100.00	*Add* For Stayfast or Topline ST11 and ST14 Only \$ 300.00	*Add* For Stayfast or Topline ST Colors and/or with Tan Lining \$ 400.00
---	--	---	---

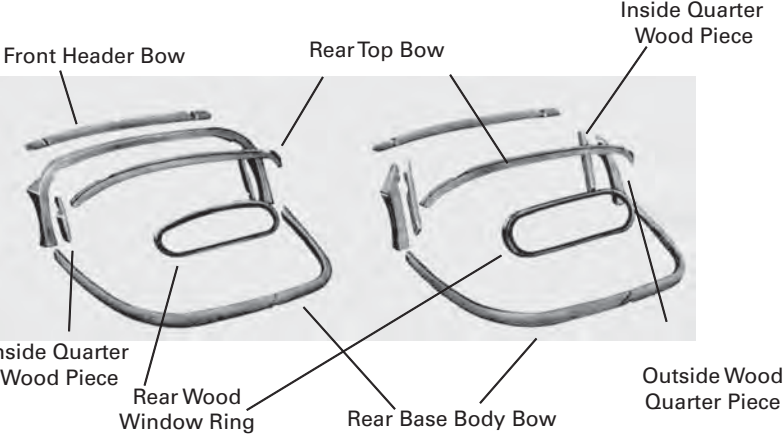
YEAR	CAR IDENTIFICATION	List Price TR01 or TR02	Stock Number	Approx Installation Time
1973-79	<div data-bbox="277 275 626 333" style="border: 1px solid black; padding: 5px; text-align: center;"> <h2>Volkswagen</h2> </div> <p>Super Beetle (Metal Front Bow)</p> <p>Headliner Available in Perforated or Crush Vinyl Rear Top Bow Rear Wood Window Ring metal attached (Fits 1973 to 1979) (Cable channel to top of ring 17") Rear Rubber Window Ring (Only fits our wood ring) 1975 & Up Plastic Window Ring (Fits 1973 to 1979) Raw Glass Measurement 11 1/8" or 11 1/2" Top Pad With Quarter Pads (Includes foam) Universal Side Cables Rear Belt Cable Bow height 23 1/2", Measure bottom cable to top bow. Note: Belt Cable Installation at Rear Body</p> 	US Dollars \$ 380.00 \$ 328.00 \$ 346.00 \$ 628.00 \$ 96.00 \$ 268.00 \$ 486.00 \$ 24.00 \$ 48.00	VW 6940	5.0
		Bow Hgt 23 1/2"		



**Compliments of
Kenny McCombs
Convertible Top Man, GA.
VW 6940**

* Labor times are based on when the cars were new *

Materials Other than Listed Above or Below, Please Call for Availability and Prices.

- | | | | |
|--|---|--|--|
| <p>*Add*
For Pinpoint OE Colors
Black Lining \$ 44.00</p> | <p>*Add*
For Pinpoint OE Colors
Tan Lining \$ 100.00</p> | <p>*Add*
For Stayfast or Topline
ST11 and ST14 Only \$ 300.00</p> | <p>*Add*
For Stayfast or Topline ST Colors
and/or with Tan Lining \$ 400.00</p> |
|--|---|--|--|

TVR VOLKSWAGEN



YEAR	CAR IDENTIFICATION	List Price TR01	Stock Number	Approx Installation Time
		US Dollars		
	Volkswagen			
1972-76	Thing Top does not include Side Curtains Note: Grommets and Straps are installed around back of top Grommets Silver in color	\$ 640.00	VW 7110	5.5
1980-93	Rabbit, Cabriolet Headliner Available in Crush Vinyl Top Pad (Includes Foam) Universal Side Cables (See Cable Pages) Rear Belt Cable (See Cable Pages) Quarter Trim Pieces (Black or White) Note: Our Top does not have Heatsealed Stitching on Quarters WE Sew our tops for Added Strength	Pe29, Pe30 or Tr01 \$ 400.00 St11 \$ 740.00	VW 7400	5.5
		\$ 332.00 \$ 486.00 \$ 24.00 \$ 118.00 \$ 70.00		Bow Hgt 25 1/4"
1995-01	Cabrio (Please Reuse Glass Windows) Headliner Available in Black, Grey-Beige or Gold Twill Side Cables (See Cable Pages)	Pe29, Pe32 \$ 400.00 St11 \$ 740.00 Sg11 \$ 840.00	VW 7660	6.0
		\$ 442.00 \$ 60.00		
2001-02	Cabrio Glass Window Tinted with Defroster Glass Window Tinted with Defroster Heated Glass Window Sealed into Top Headliner Available in Black, Grey-Beige or Gold Twill Side Cables (See Cable Pages) Brackets Note: We recommend installing brackets using a 2 part urethane. Brackets can be installed with a 2 part epoxy or 3M Adhesive. Please Allow 4-5 Working Days for manufacturing.	Pe29 \$ 1000.00 St11 \$ 1240.00 Sg11 \$ 1340.00	VW 7820	7.0
		\$ 442.00 \$ 60.00 \$ 60.00		
2003-08	Beetle (Manual Model) Our top has a small front pad with extrusion cord and metal brackets. Side Cables (See Cable Pages)	Call \$ Call	VW 7840	
2003-08	Beetle (Power Model) Our top zips to the top pad and has metal brackets around the glass window. Side Cables (See Cable Pages)	Call \$ Call	VW 7841	
	VOLVO			
1998-07	C 70 (Glass Window Tinted with Defroster) Glass Window Built into Top Side Cables (See Cable Pages) Please Allow 4-5 Working Days for Manufacturing Note: Our Top has a Zipper Around Rear Window for the Headliner	St11, St13 \$ 1240.00 Sg11, Sg13 \$ 1340.00	VO 7890	8.0
		\$ 240.00		

* Pricing below is for tops only not accessories *

Materials Other than Listed Above or Below, Please Call for Availability and Prices.

***Add* To PE**
For OE or PE Colors
Black Lining \$ 44.00

Add To ST11
For ST Colors Not Listed
and/or with Tan Lining \$ 100.00

Add to SG11
For SG Colors Not Listed
and/or with Tan Lining \$ 100.00

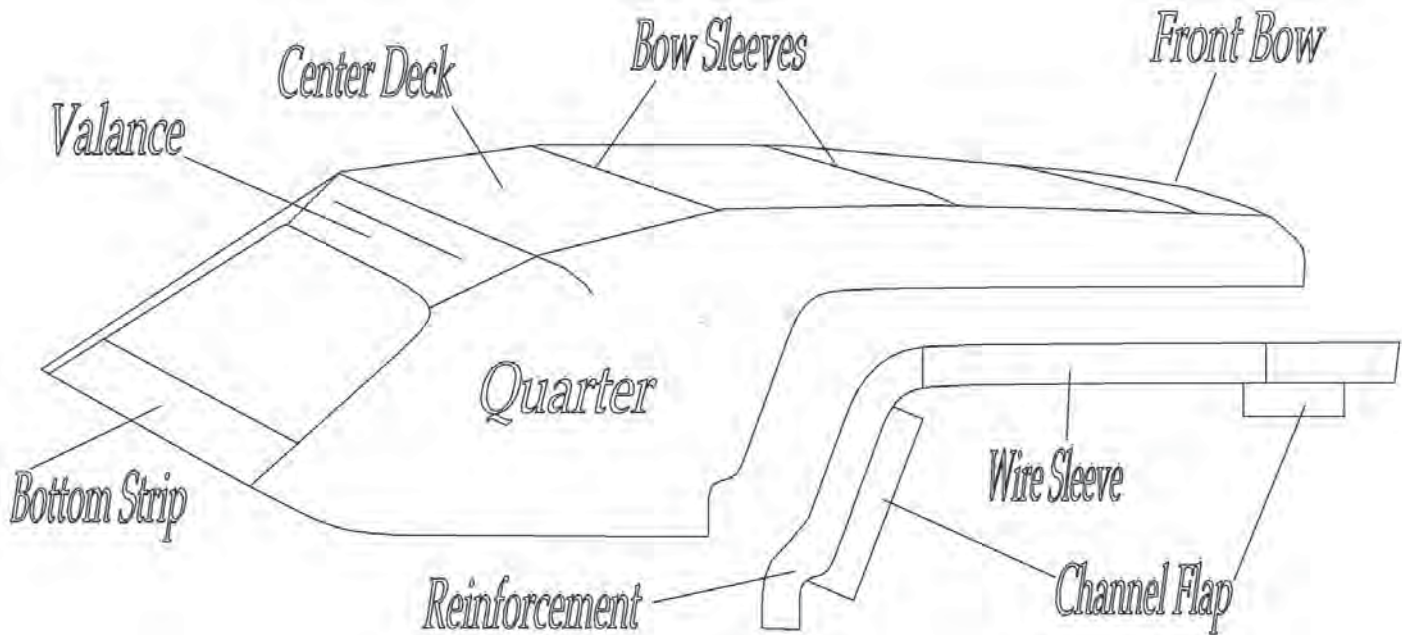

How to Measure a Bow Height

For Cars that install inside the body opening; measure from the center of the rear bow down to the chrome molding around the body opening.

For Cars that install outside the body opening; measure from the center of the rear bow down to the deck of the trunk.



126-15 89th Ave.
Richmond Hill, N.Y. 11418
Web Address www.electrontop.com

For Info Call (800) 221-4476
Local (718) 846-7400
To Fax (718) 846-8426
E Mail info1@electrontop.com

Let us introduce you to our distributors.

Special Interest Distributors**

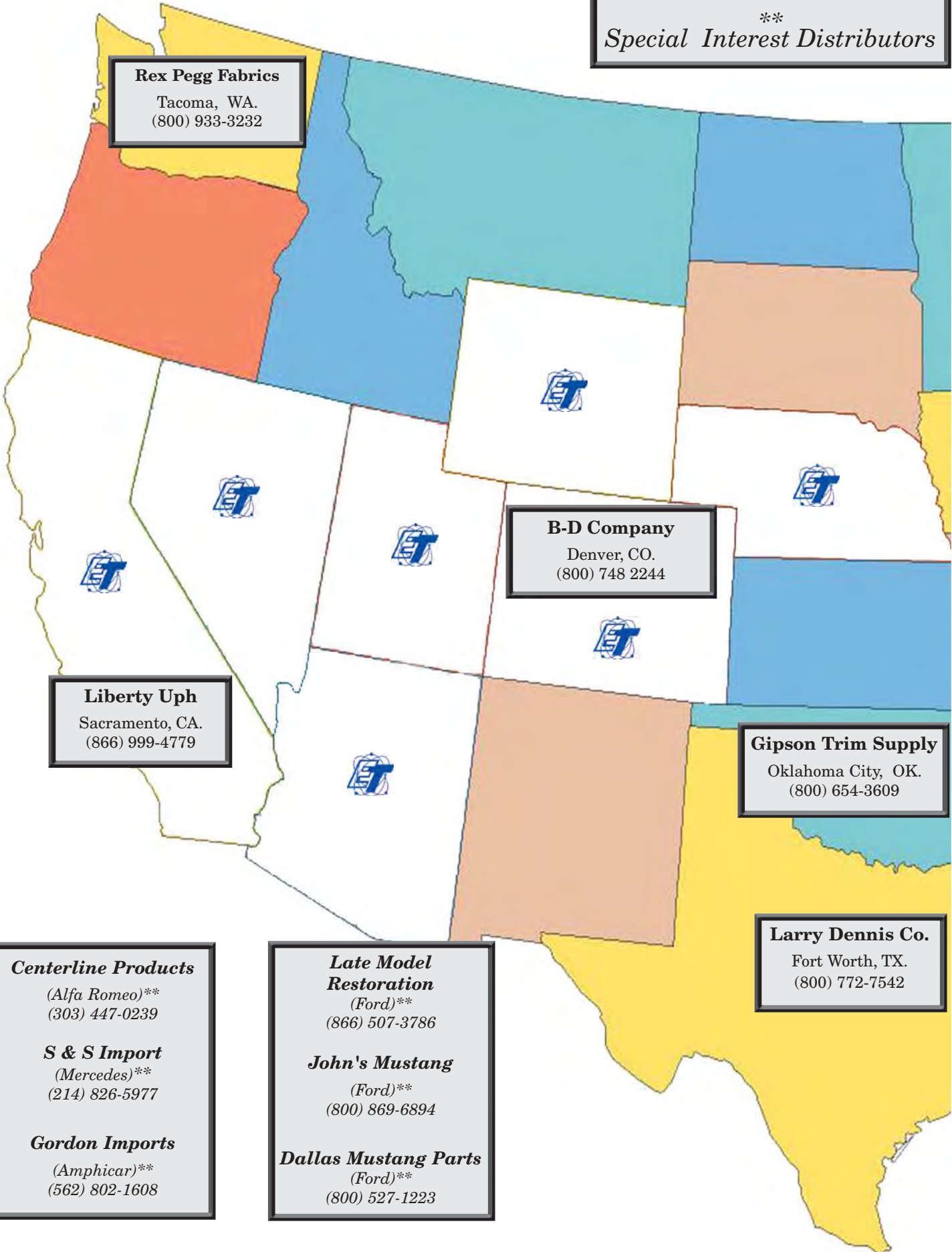

Rex Pegg Fabrics
Tacoma, WA.
(800) 933-3232

Liberty Uph
Sacramento, CA.
(866) 999-4779

B-D Company
Denver, CO.
(800) 748 2244

Gipson Trim Supply
Oklahoma City, OK.
(800) 654-3609

Centerline Products
*(Alfa Romeo)***
(303) 447-0239

S & S Import
*(Mercedes)***
(214) 826-5977

Gordon Imports
*(Amphicar)***
(562) 802-1608

Late Model Restoration
*(Ford)***
(866) 507-3786

John's Mustang
*(Ford)***
(800) 869-6894

Dallas Mustang Parts
*(Ford)***
(800) 527-1223

Larry Dennis Co.
Fort Worth, TX.
(800) 772-7542

Electron Top has distributors all around the U.S.A. and in some foreign countries. WE want to make sure our product is always available to you!!

The image features a map of the United States with various states highlighted in different colors (blue, yellow, orange, purple, green). Numerous 'ET' logos are placed across the map, indicating distributor locations. Several callout boxes provide contact information for specific distributors. A large callout box in the center-right contains the company name and slogan. A vertical list on the right side of the map provides details for several specialty distributors.

Distribution-DNR
Granby, Canada
(800) 363-5972
(450) 372-4940

USA-Trading Co.
Sweden
011 46 521 224080

Pyramid Trim Supply
St Paul, MN.
(800) 333-8746

Electron Top
"Our Reputation is Tops"
New York
(800) 221-4476
(800) 522-3100

Maryland Mustang
(Ford)**
(410) 987-5353

Clark's Corvair
(Corvair)**
(413) 625-9776

Cadillac USA Parts
(American Cars)**
(800) 872-2013

Convertible Top Specialist
(American & Foreign Cars)**
(800) 272-2394

Tee-Bird Products
(Thunderbirds)**
(800) 423-3723

Performance Years
(GTO)**
(800) 542-7278

Roo Sports
(Capris)**
(503) 919-4227

Legendary Auto Int.
(1953-86 American Cars)**
(800) 363-8804

Camaro Specialties
(Camaro)**
(716) 652-7086

IDC/Smart Supply
Duncan SC.
(866) 585-8365

Woolley Bros. Inc.
Jackson, MS.
(800) 222-5447

A & B Top & Textile
W Palm Bch, FL.
(800) 244-1580
Ft Lauderdale, FL.
(800) 656 8066

Cables



Size
21"

AD 5190
2000-2006 Audi TT
Side Cables



Size
36 1/4"

BM 8090
1987-93 BMW 318, 320 and 325i
Side Cables



Size
29 1/4"

BM 8110
1994-00 BMW 318, 323 and 325i
Side Cables

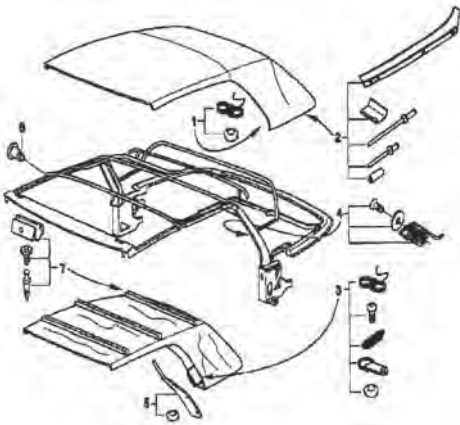

BM 8110
1994-00 BMW 318, 323 and 325i
String Kit & Stiffeners
for Headliner Sold Separately



Size
14"

BM 8120
1996-02 BMW Z3
Repair Kit for
Side Cables



Size
36 1/2"

CH 4090
1967-69 Plymouth Barracuda
Side Cables



Size
36 1/4"

CH 4190
1970-71 Dodge Challenger
1970-71 Plymouth Barracuda
Side Cables



Sizes
31 1/4"
33"
33 1/4"
35 1/4"

CH 4820, CH 4860, CH 4900,
1982-86 Chrysler LeBaron, 400, 600
1987-95 Chrysler LeBaron
Side Cables



Sizes
27 1/8"
36"

CH 4920 and CH 4940
1990-93 Dodge Shadow
1996-05 Chrysler Sebring
Side Cables

Cables



Size
33 3/4"

CH 5010

2007-12 Chrysler Sebring
Chrysler 200
Side Cables



Size
24"

CH 5460

2004-09 Chrysler Crossfire
Side Cables



Size
29 5/16"

FO 3460

1964-66 Ford Thunderbird
Side Cables



Size
28"

FO 3510

1964 1/2-68 Ford Mustang
Side Cables



Sizes
24 1/2"
34"

FO 3560 and FO 4140

1965-66 Ford Full Size Cars
1965-66 Mercury Full Size Cars
1971-73 Ford Mustang
Side Cables



Sizes
28 1/2"
31 1/4"
35 1/4"
29"

**FO 3620, FO 4110, FO 4120 &
FO 4130**

1967-70 Ford Mustang
1968-71 Ford Mid & Full Size Cars
1968-71 Mercury Mid & Full Size Cars
Side Cables



Sizes
34 5/8"
35 3/4"
38 3/8"

FO4160 and FO4200

1983-93 Ford Mustang
Side Cables



Sizes
23"
26"

FO 4230 and FO 4250

1990-94 Mercury Capri
Side Cables



Size
17"

FO 4230 and FO 4250

1990-94 Mercury Capri
Rear 1/4 Cables

Cables



Sizes
35 1/8"
35"
36 1/2"

FO 4280 and FO 4290
1994-04 Ford Mustang
Side Cables



Size
14 3/4"

FO 4280 and FO 4290
1994-04 Ford Mustang
Rear 1/4 Cables



Size
52 1/2"

FO 4300
2005-14 Ford Mustang
Side Cables



Size
28"

FO 4330
2001-05 Ford Thunderbird
Side Cables



Sizes
36 3/4"
38"
41 1/4"

GM 3070, GM 3220 and GM 3410
1961-64 Full Size Cars GM
1964-65 Mid Size GM
Side Cables



Size
34"

GM 3660
1966-67 Mid Size GM
Side Cables



Size
34"

GM 3680
1968-72 Mid Size GM
Side Cables



Size
31"

GM 3720 and GM 3740
1967-70 Chevrolet Camaro
1967-70 Pontiac Firebird
Side Cables



Size
9"

GM 3780
1973-75 Chevrolet Corvette
Rear Bow Cables

Cables



Size
19"

GM 3780
Late 1968-75 Corvette
Side Cables



Size
12 3/4"

GM 3781
Early 1968 Corvette
Side Cables



Sizes
23 1/8"
27 3/8"
32 1/2"

GM 3800, GM 4870 and GM 4880
1986-93 Chevrolet Corvette
1983-87 Chevrolet Cavalier
1983-87 Pontiac Sunbird
1982-86 Full Size GM
Side Cables



Size
32 1/4"

GM 3820, GM 3830, GM 3850,
1987-93 Camaro & Firebird
Side Cables



Sizes
23"
29"

GM 3860
1994-04 Chevrolet Camaro
1994-04 Pontiac Firebird
Side Cables



Size
30"

GM 3880
1998-04 Chevrolet Corvette
Side Cables



Size
25 1/2"

GM 3940
2005-10 Chevrolet Corvette
Side Cables



Size
67"

GM 4730
1972-76 Full Size GM Scissor Frame
Universal Style
Side Cables



Sizes
38 1/2"
66 1/2"

GM 4731 and GM 4733
1971-76 Full Size GM Scissor Frame
Original Style Left and Right
Side Cables

Cables



Size
9"

GM 4871 and GM 4910
1983-98 Chevrolet Cavalier
1983-98 Pontiac Sunbird
Rear 1/4 Cables



Sizes
32 1/8"
32 1/2"
32 1/4"

GM 4910, GM 4970 and GM 5060
1988-94 Cavalier & Sunbird
1988-94 Cavalier & Sunbird
Side Cables



Size
39 1/2"

GM 4980
1990-94 Oldsmobile Cutlass
Side Cables



Size
26 3/4"

GM 4980
1990-94 Oldsmobile Cutlass
Rear 1/4 Cables



Sizes
29 1/2"
29 1/4"

GM 5070 and GM 5090
1995-97 Chevrolet Cavalier
1996-97 Pontiac Sunfire
Side Cables



Size
33"

GM 5100
1990-93 Chevrolet Geo Metro
Side Cables



Sizes
38 3/4"
41 5/8"

GM 6571 and GM 6572
1965-70 Full Size Cars GM
Side Cables



Size
21 3/4"

HO 8300, HO 8305 and HO 8310
2000-09 Honda S 2000
Side Cables



Size
86 3/4"

JA 7560
1989-95 Jaguar XJS
Rear Belt Cable



Sizes
26 1/4"
30 1/4"

MI 5200 and MI 5220
1996-99 Mitsubishi Eclipse
2000-05 Mitsubishi Eclipse
Side Cables



Size
40 1/2"

MI 5240
2006-10 Mitsubishi Eclipse
Side Cables



Size
26 7/8"

MZ 8350 and MZ 8370
1989-97 Mazda MX-5 Miata
Side Cables



Size
26 3/4"

MZ 8380 and MZ 8400
1999-2011 Mazda MX-5 Miata
Side Cables



Sizes
32 1/4"
29"

NS 5350, NS 5400 and NS 5410
1992-94 Nissan 240 SX
1993-96 Nissan 300 ZX
2004-09 Nissan 350 Z
Side Cables



Size 22 3/4"



Sizes
32 1/4"
38"
40 1/4"

SB 7080, TY 7610 and TY 7710
1987-94 Saab
1987-89 Toyota Celica
1994-99 Toyota Celica
Side Cables



Size
26"

TY 7480
1984-85 Toyota Celica
Side Cables



Size
33 1/2"

SB 7950
1995-98 Saab 900
Side Cables

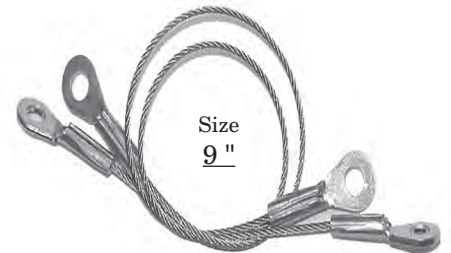

Size
9"

SB 7980
1999-03 Saab 93
Side Cables

Cables



Size
29 1/2"

TY 7680
1991-93 Toyota Celica
Side Cables



Size
42"

TY 7720
1997-98 Toyota Paseo
Side Cables



Size
35 3/8"

TY 7830 and TY 7910
1998-09 Toyota Solara
Side Cables



Size
25 1/2"

VO 7890
1998-2007 Volvo C 70
Side Cables



Sizes
78"
90"
89 1/2"

**VW 6760, VW 6940,
VW 6810 and VW 6850**
1967-79 Volkswagen Beetle
1967-76 Karmann Ghia
Rear Belt Cable & Rear Window Cable



Size
93 3/4"

VW 7400
1980-93 Rabbit Cabriolet
Rear Base Cable



Size
43"

VW 7660
1995-02 Volkswagen Cabrio
Side Cables



Size 21 7/8"

VW 7840
2003-10 Volkswagen Beetle
Side Cables



Size
9 Ft

Universal Cables
Two loop with three ferruls to
make two more loops
available with or without springs

BMW Tension Straps

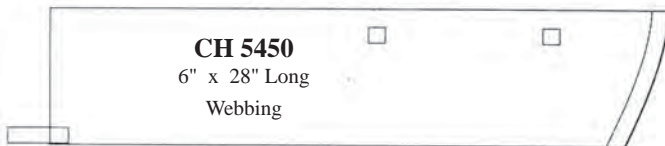
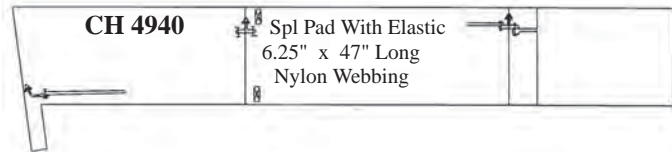
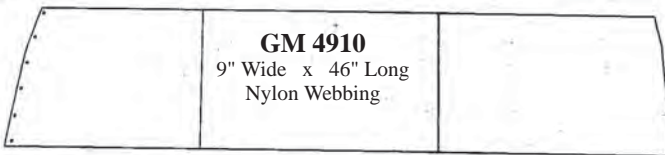
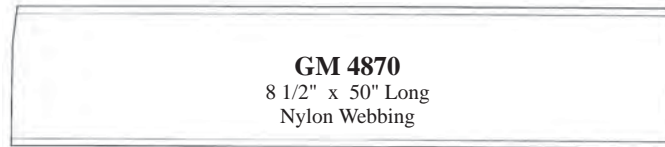
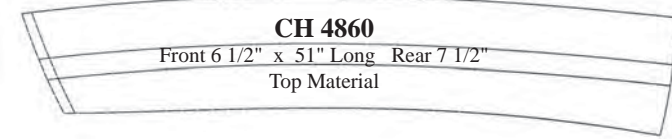
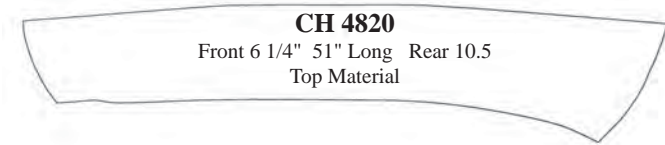

BM 8090

We manufacture our own tension straps for all the 1987-93 BMW 3 series convertible tops. They are 1.5" x 67 1/4" long, made of strong tubular webbing with a heavy quality elastic interior and two expansion webbing bands similar to the original.



BM 8110

We manufacture our own tension straps for all the 1994-99 BMW 3 series convertible tops. They are 2" x 67 1/2" long made of webbing with heavy quality elastic including an expansion band and three smaller loops consisting of elastic and grommets.

**** WARNING **** Always change the tension straps when replacing a convertible top on these model BMW cars. Please see our "Tension Strap Warning Below".

Warning: Tension straps aid in the folding operation on both power and manual model BMW convertibles. Straps have spring loaded plastic bands located on the top of the straps towards the front and sometimes the rear of the vehicle. These bands are flat until the top drops back during the folding operation and the tension on the strap is relaxed. The spring loaded bands will then bow upward pushing the top away from the frame.



Std Rear Quarter Pad

30" Long
Top Material

FO 1580

10" x 30" Long
Top Material

FO 3090

FO 3460

9" x 24" x 15" Long
Top Material

NA 3320

7" x 23" x 9 1/2" Long
Top Material

FO 3450

5 3/8" x 30" Long
Top Material

FO 3510

4.5" x 25" x 15" Long
Webbing

FO 3620

8" x 23" x 14 3/4" Long
Webbing

FO 3670

8.5" x 24" x 15" Long
Top Material

GM 3800 and GM3810

3 1.2" x 7" x 16" Long
Top Material

FO 4110

7" x 32" x 14"
Long Webbing

FO 4120

5 1/2" x 34" x 22 1/2" Long
Top Material

FO 4130

7 1/2" x 31" x 15" Long
Top Material

FO 4140

7 1/2" x 31" x 15" Long
Top Material

FO 4160

6 1/2" x 29 1/4" x 12 1/2" Long
Top Material

FO 4200

6.5" x 24.25" x 12 1/2" Long
Webbing

CH 4820

6 1/2" x 30" x 12 3/4" Long
Top Material

SB 7080

6 3/4" x 8 1/2" x 23" Long
Webbing

TY 7610

22" Long
Webbing

“That’s why WE at *Electron Top* only use first quality fabric for all of our domestic and foreign topping needs.”

Materials

- CN (Concord)** is a 32 to 36 oz. single textured material with a heavy cotton lining available in Crush (Chrysler Grain) and Levant (Porsche Grain). The material differs from O.E.C. in grain only (Limited Stock).
- IB (Bison)** is a 32 to 36 oz. single textured material made to look like British Everflex. It is produced by The HAARTZ Corp. on a black cotton lining (Limited Stock).
- GR (Sonnenland)** is a 3 ply polyester and acrylic face fabric material made by The HAARTZ Corp - RSI in Germany, and has a cotton dobby lining. It is original on Mercedes, some BMW, Porsche and Saab motor cars. It is available in many colors on a black or tan cotton lining.
- HT (Honda Twill)** is a 38 oz. single textured twill grain material with a poly/cotton lining available in black and white. The HT01 black has a drill backing and the HT02 white has a poly/cotton sheeting.
- HR (Hot Rod/Stayfast)** is a 3 ply, acrylic face fabric, solution dyed and combined to an elastomer membrane on 100% cotton lining. The face fabric is FADE RESISTANT and is available on a black lining with the exception of the Oyster which is only available on a tan lining.
- OE (O.E.C.)** {Original Equipment Color} is a 36 oz. single textured material with a cotton lining, available in a large selection of colors. Some colors might be 32 oz.
- PE (Pigskin)** is a 38 oz. single textured material with a grain similar to the original Wolfsburg grain. Black and White come with a poly/cotton lining, all others have a 100% cotton lining.
- SA (Sailcloth)** is a 34 oz. single textured material with a charcoal colored poly/cotton lining. It is O.E.M. for Chrysler models 1990-up.
- SE (Sailcloth/Eurotopping)** is a 36oz. single textured material with a black poly/cotton synthetic lining and is available 60” wide. It is stronger than single texture and is replacing Tufflex on Ford models 1997-up.
- ST (Stayfast ®)** is a 3 ply, acrylic face fabric, solution dyed and combined to a rubber elastomer membrane on a 100% cotton lining. The face fabric is FADE RESISTANT and is available on a black or tan lining.
- TL (Topline)** is an acrylic face fabric, solution dyed and combined to a rubber elastomer membrane on a 100% cotton lining. The face fabric is FADE RESISTANT and is available on a black or tan lining.
- TG (Topline/G)** is a Twill weave, acrylic face fabric, solution dyed and is combined to a rubber elastomer membrane on a dobby lining like the Sonnenland. It is made by Top-Line Automotive LLC. The face fabric is FADE RESISTANT and is available on a black or tan lining.
- TR (Trojan)** is a 36 oz. single textured material with a heavy cotton sateen lining.
- TS (Pinpoint/Eurotopping)** is a 36 oz. single textured material with a black poly/cotton synthetic lining and is available 60” wide. It is stronger than Trojan and is replacing Tufflex on GM Cars.
- SG (TwillFast/G ®)** is a 3 ply, 100% acrylic face fabric with a Twill weave and has a dobby lining like the Sonnenland. The face fabric is FADE RESISTANT and is available on a black or tan poly/cotton lining. It is O.E.M. on some Audi, BMW, Corvette, Porsche, Saab, Volvo and VW motor cars.
- ST (TwillFast ®)** is a 3 ply, acrylic face fabric, solution dyed with a Twill Weave and combined to an elastomer membrane on a 100% cotton lining. The face fabric is FADE RESISTANT and is available on a charcoal colored poly/cotton lining. It is O.E.M. on Chrysler models.

126-15 89th Ave.
Richmond Hill, N.Y. 11418
Web Address www.electrontop.com

For Info Call (800) 221-4476
Local (718) 846-7400
To Fax (718) 846-8426
E Mail info1@electrontop.com

Electron Top's Sales Team



[Skip – Technology]
Responsible for our patterns,
computer programs, sewing and
heat sealing machine technology.

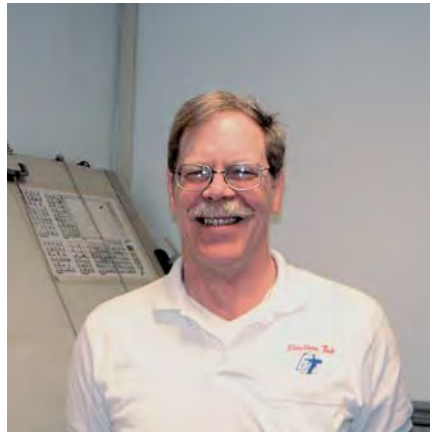

[Rick – Retired]
Answers installation questions,
produces our rare tops and
fabricates special equipment.



[Kimmy – Historian]
Office Management - Accounts
payable, sales, and
newsletter.



[Fina - Experience]
Phone Sales - came up through the
ranks from sewing to sales
representative.



[Cathy - Friendly]
Phone Sales - Started with Electron
in Sept 1998. Will always greet you
with a warm hello.



[Tracey - Smiley]
Phone Sales, Accts Receivable -
Always happy and looks forward to
helping our customers.



[Kitty (Mom) - Humble Support]
Mom has been around since the birth
of *Electron Top*. She reminds us
...."WE are family first."

Electron Top Mfg. Co. Inc.

126-15 89th Ave

Richmond Hill, N.Y. 11418

Call Toll Free (800) 221-4476

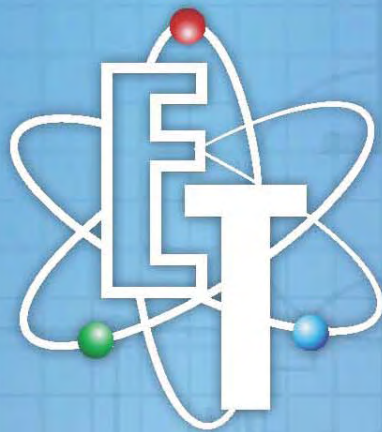

MANUFACTURING CO.

Custom Quality at a Fair Price